

Catalog No. 15



HORST

Heating Tapes
Heating Hoses
Temperature Regulators
Heating Jackets
Special Heatings

Contents

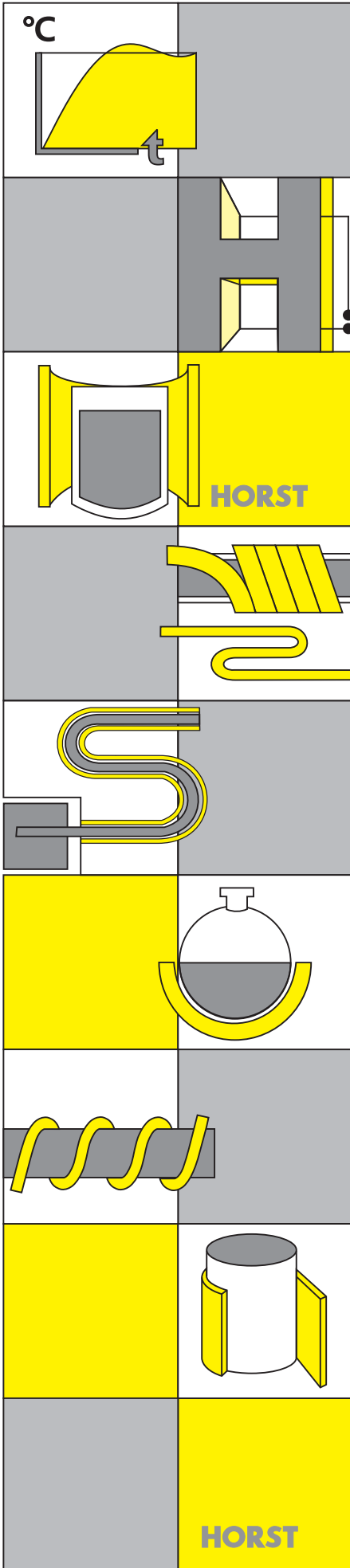

Special Models.....	3
Heating Tapes.....	5
Mounting Accessories	17
Heating Mats	22
Silicone Heating Mats	23
Heating Jackets	24
Flange Heatings.....	26
Insulating Jackets	26
Barrel Heatings.....	27
Tube Furnaces.....	28
Gas Heaters / Circulation Heaters.....	29
High Performance Cartridge Heaters.....	30
Heating Plates	32
Heating Hoses	33
Temperature Regulators	43
Temperature Sensors.....	57
Heating Mantles.....	59
Index	62
Notes.....	63

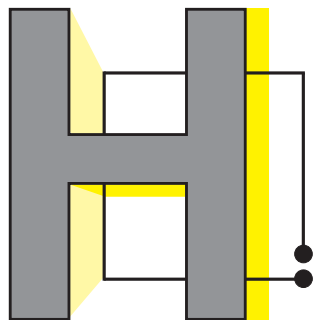

HORST

Electrical Heating and Regulation Made to Fit

Our range of products for technical centers and industry is based on more than 25 years of experience in designing and producing electrical heatings.

We have a wide range of heatings and temperature regulators in stock, which perfectly solve most heating problems. Our range of accessories is especially adapted to our components and guarantees an easy and comfortable installation for you or the assigned electrician.

It is sometimes more economic and efficient to find an individually-adapted solution for a heating problem. Together we will work out a suitable combination of components or we will suggest a special model that covers all aspects of your heating application.

Examples of Special Models

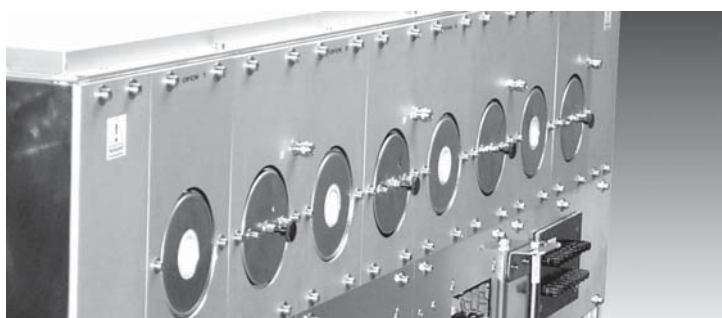

Eight Tube Furnaces in a Joined Casing

For a customer application in the production field eight tube furnaces in one housing were required. Each furnace insert is cooled by a cooling circuit. This minimizes the heat radiation and the ambient temperature stays bearable.

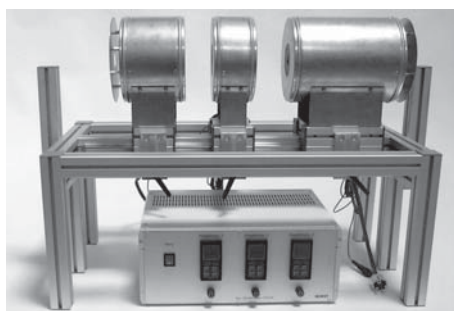

Movable Three-Part Tube Furnace

Three segments of a cylindrical reactor have to be heated with varying temperatures. The tube furnaces are mounted on a sliding rail.

The temperature is controlled by three programmable regulators, integrated in one housing.

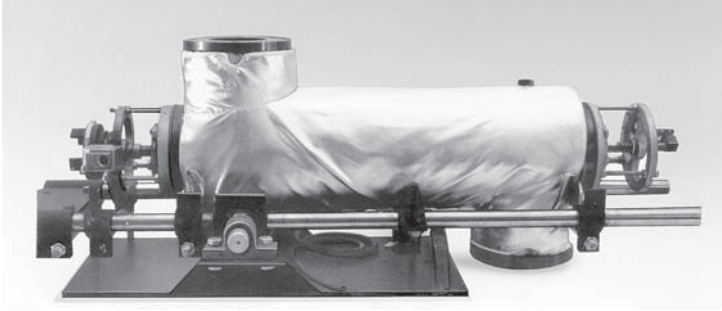

Reactor Heating up to 800 °C

In a pilot plant for recycling plastic-coated aluminum, a temperature of 800 °C is required, to separate plastic and aluminum in the reactor with a conveyor spiral. Several separate control circuits produce a perfectly adapted heat distribution.



Six Connection Lines Integrated in One Heating Hose

One heating hose is split into six individually heated lines, each to be connected to injection nozzles.

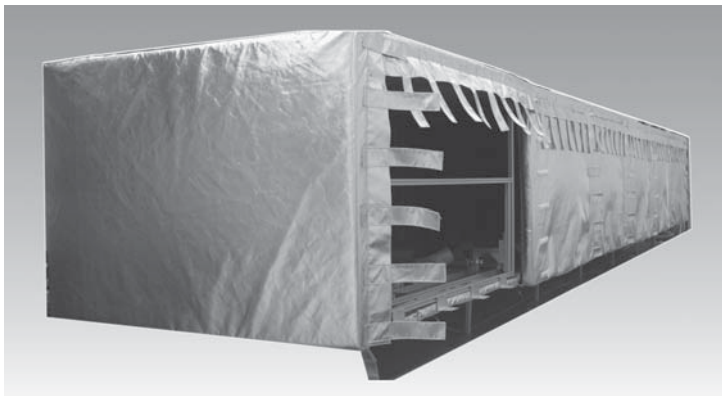

Bakeout Tent for Heating Complex Geometries

A complex, eight-meter-long component is to be heated. A thermally insulated bakeout tent was designed, to uniformly heat the component using circulation blowers.

Design:

Modularly-designed electrical heating batteries with air circulation blowers screwed onto an aluminum self-supporting frame. Temperature is measured at the air outlet as well as inside the tent to protect the heating element from overheating.

The number of heating batteries depends on the size of the bakeout tent and the desired operating temperature. The textile heat insulation encloses the component to be heated and is partially detachable.

The insulation elements are fixed and connected with velcro fasteners and tension bands.

Pic. 1: Side view of a bakeout tent with detached insulation element

Pic. 2: Interior view showing heating batteries mounted on the bottom. The heating batteries can also be positioned on the side.

Pic. 1



Pic. 2

HORST Heating Tapes

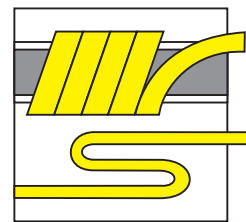

Heating tapes and heating cables can be additionally attached to different types of existing installations. Our range of products includes suitable heatings for cylindrical forms, such as thin cables, pipes or containers as well as for surfaces or armatures. Heating tapes or heating cables can be used to compensate a lack of insulation in order to keep a certain temperature of a component or its contents. Furthermore, they can be used to increase the temperature of components and their contents.

The following questions can be helpful to select an appropriate model for your application:



What heating power is required?

It is necessary to define the desired heating effect in order to select a suitable heating tape. Based on the required operating temperature, the heating power can be calculated. A heating tape or heating cable with suitable technical data can be selected depending on the available surface for mounting.



Which ambient conditions have to be considered?

For an application in humid conditions, we offer plastic-insulated types for temperatures up to 250 °C. Textile-insulated heating tapes for an operation in dry conditions can reach temperatures of 450 °C or even up to 900 °C. Further criteria are mechanical stress during mounting or operation as well as safety restrictions for the application in explosive areas, where self-limiting heating tapes are especially suitable for temperatures up to 200 °C.



Temperature Regulation and Mounting

Most heating tapes have to be temperature-controlled during operation. If an installed heating can cause damage following a failure of the temperature regulator, an additional protection against overheating is required. For suitable temperature regulation devices, please refer to pages 43 – 55. Accessories for quick and material-specific mounting, fixing or heat insulation can be found on pages 17 – 21.

Please note that the selection of components and the installation have to be carried out by an electrician to guarantee safe operation.

Heating Tapes

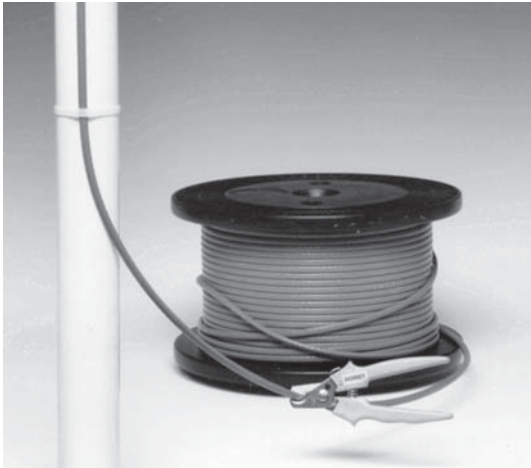

Heating Cable by the Meter for Self-Finishing

The heating cable types HKSI and HKPT are especially designed for heating of industrial installations, rainwater gutters, pipes, containers and similar applications outside or in humid areas.

They are sold by the meter according to customers requirements and can be directly installed on the object with our special finishing sets. Alternatively, heating cables can be delivered operational in every required length.

The coiled heating conductor is segmented into heating zones of 0.7 m (HKSI) or 0.67 m (HKPT). Cutting and mounting is very easy: just cut through the heating conductor at the marked supply point. This heating zone loses its function but is used as a connecting line and can be shortened individually.

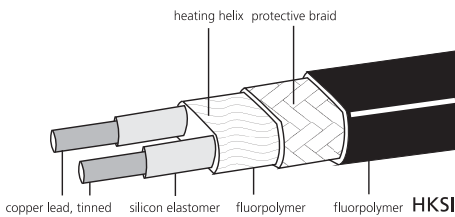

HKSI - 150 °C

Robust Heating Cable

A fluoropolymer mantle protects this heating cable from effects of chemical substances and permits use in an aggressive environment up to a working temperature of 140 °C.

Technical Data.

nominal temperature:	140 °C
nominal voltage:	230 V~
heating power rate:	30 W/m
segment length:	0.7 m
min. bending radius:	35 mm
thickness:	6 mm
breadth:	9 mm
protective braid:	copper, tinned
humidity-proof	

order no.

02 12 04	HKSI 30 W/m
02 16 70	finishing Set HKSI: heat shrinkable tubing sections, one flat-sealing cable gland for the housing inlet, and small parts for the electrical connection
02 12 31	ready-made finish

Please note that the total length has to be divisible by 0.7. For finishing with finishing set 02 16 70, an additional 0.7-m-segment is required. This addition is included if you order a heating cable with ready-made finishing 02 12 31.

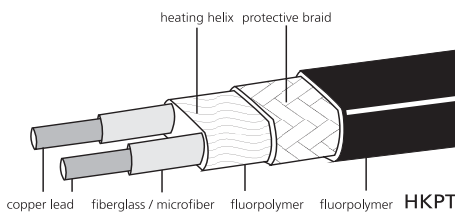

HKPT - 249 °C

Robust Heating Cable for High Working Temperatures

HKPT combines high temperature stability and extreme chemical resistance of its Fluoropolymer mantle.

Technical Data

nominal temperature:	249 °C
nominal voltage:	230 V~
heating power rate:	30 W/m
segment length:	0.67 m
min. bending radius:	35 mm
thickness:	7.5 mm
breadth:	10.3 mm
protective braid:	copper, nickel-plated
humidity-proof	

Please note that the total length has to be divisible by 0.67. For finishing with finishing set 02 16 55, an additional 0.67-m-segment is required. This addition is included if you order a heating cable with ready-made finishing 02 12 35.

order no.

02 12 12	HKPT 30 W/m
02 16 55	finishing Set HKPT: heat shrinkable tubing sections, one flat-sealing cable gland for the housing inlet, and small parts for the electrical connection
02 12 36	ready-made finishing

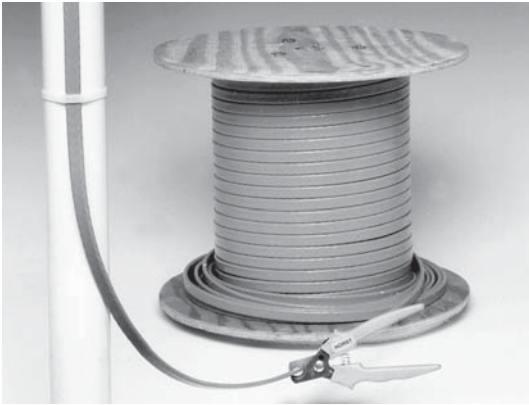

Self-Limiting Heating Tapes

Self-limiting heating tapes continuously adapt their heating power depending on the surface temperature. The heating power increases when the temperature falls, it decreases when the temperature rises.

Under normal conditions of use this attribute prevents the heating tape from overheating.

In addition to the use as anti-freeze heating, a typical application is heat loss compensation of pipe sections and containers with media temperatures higher than ambient temperature.

The temperature specifications of self-limiting heating tapes (e.g. "65 °C", "85 °C") refer to the maximum admissible surface temperature where the heating tape should be installed. Depending on installation and operating conditions, the heating tape temperature may deviate from these temperature values during operation.

Self-limiting heating tapes are available with different heating power rates (Watt/m) based on 5 °C respectively 10 °C heating tape temperature. The characteristic diagrams show the development of heating power in relation to the surface temperature of the heating tape.

In order to select a suitable heating tape, based on the desired temperature range the required heating power will be determined. The calculation of the heating tape length for the needed heating power must consider the decreasing power rate at rising temperatures according to the characteristic diagrams.

Self-limiting heating tapes may be cut to any length shorter than the maximum heating circuit length. On-site or factory-made finishes are possible. Please contact us if you need any assistance.

Self-limiting heating tapes can also be used in combination with a temperature regulator.

On request other nominal voltages are available.

HBRA - 65 °C max. Ambient Temperature Self-Limiting Heating Tape for Anti-Freeze

Reasonably-priced heating tape, equipped with high-quality fluoropolymer mantle. Due to its dimension and its power characteristics, this heating tape is designed for anti-freeze heating of pipe sections.

Technical Data

max. allowed ambient temperature: 65 °C energized, 80 °C de-energized
 nominal voltage: 230 V~
 min. bending radius: 25 mm
 breadth: 13.8 mm
 thickness: 5.6 mm
 protective braid: copper, tinned
 outer mantle: fluoropolymer
 temperature class: T6 (85 °C), referring to ATEX directive
 additional length for finishing: 210 mm
 humidity-proof

order no.	Watt/m	reference temp.
02 14 25	20	10 °C
02 14 30	30	10 °C

order no. HBRA finishes (see page 9)

order no.	option	description
02 16 09	option 1	finishing set for direct entry into connection box shrink technology, cable gland M25
02 16 14	option 3	finishing set for direct connection heating tape - power supply line plug-and-socket technology
02 17 09	option 4	factory-made direct connection heating tape - power supply line (rubber cable)

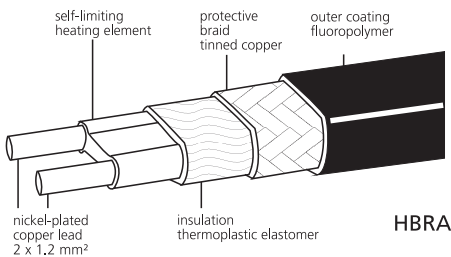

HBRA

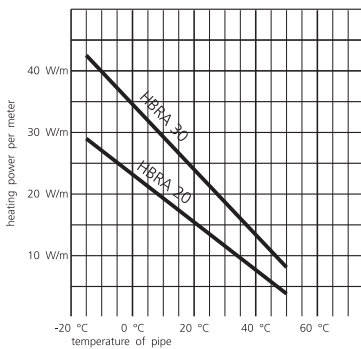

heating power subject to ambient temperature

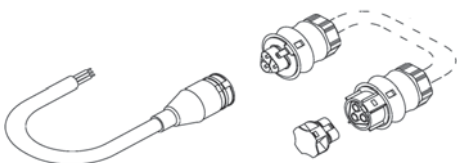

pic.: finishing set HBRA option 3: for direct connection to a power supply line

Heating Tapes

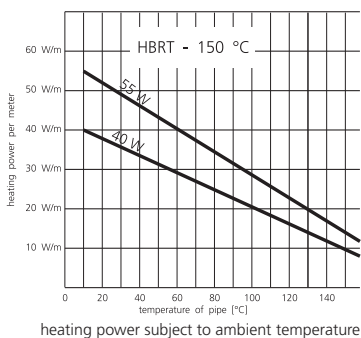
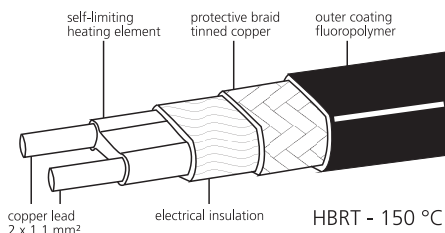
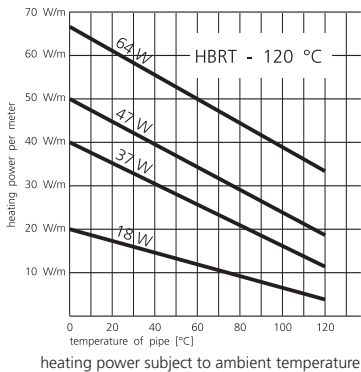
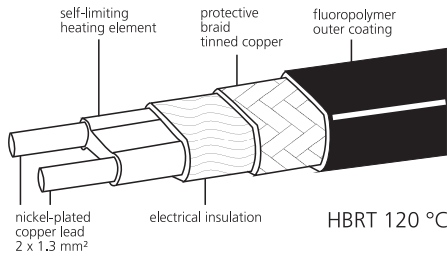
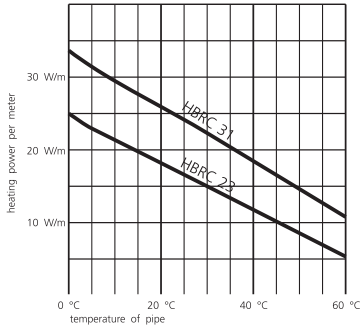
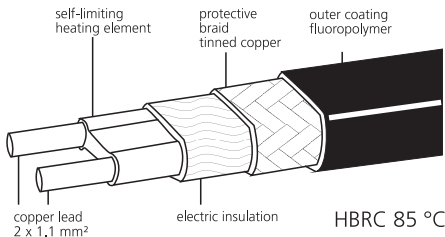

HBRC - 85 °C max. Ambient Temperature Self-Limiting Heating Tape

Technical Data

max. allowed ambient temperature: 85 °C energized, 85 °C de-energized
 nominal voltage: 230 V~
 min. bending radius: 35 mm
 breadth: 10.5 mm
 thickness: 5.9 mm
 protective braid: copper, tinned
 outer mantle: fluoropolymer
 additional length for finishing: 150 mm
 humidity-proof

order no.	Watt/m	reference temp.	temperature class
02 14 44	23	5 °C	T6 (85 °C), referring to ATEX directive
02 14 46	31	5 °C	T4 (135 °C), referring to ATEX directive

HBRC 85 Finishes

order no.	HBRC 85 finishes (see page 9)
02 16 16	option 1 finishing set for direct entry into connection box shrink technology, cable gland M25
02 17 16	option 2 factory-made finish with connection box
02 16 18	option 3 finishing set for direct connection heating tape - power supply line screw technology
02 17 18	option 4 factory-made direct connection heating tape - power supply line (rubber cable)

HBRT - 120 °C max. Ambient Temperature Self-Limiting Heating Tape

Technical Data

max. allowed ambient temperature: 120 °C energized, 205 °C de-energized
 nominal voltage: 230 V~
 min. bending radius: 10 mm
 breadth: 11.2 mm
 thickness: 5.2 mm
 protective braid: copper, tinned
 outer mantle: fluoropolymer
 additional length for finishing: 150 mm
 humidity-proof

order no.	Watt/m	reference temp.	temperature class
02 15 02	18	10 °C	T3 (200 °C), referring to ATEX directive
02 15 01	37	10 °C	T3 (200 °C), referring to ATEX directive
02 15 00	48	10 °C	T3 (200 °C), referring to ATEX directive
02 15 15	64	10 °C	T2 (300 °C), referring to ATEX directive

HBRT 120 finishes (see page 9)

02 16 05	option 1	finishing set for direct entry into connection box shrink technology, cable gland M25
02 17 01	option 2	factory-made finish with connection box

HBRT - 150 °C max. Ambient Temperature Self-Limiting Heating Tape

Technical Data

max. allowed ambient temperature: 150 °C energized, 200 °C de-energized
 nominal voltage: 230 V~
 min. bending radius: 30 mm
 breadth: 12.2 mm
 thickness: 5.2 mm
 protective braid: copper, tinned
 outer mantle: fluoropolymer
 additional length for finishing: 130 mm
 humidity-proof

order no.	Watt/m	reference temp.	temperature class
02 15 23	40	10 °C	T3 (200 °C), referring to ATEX directive
02 15 26	55	10 °C	T3 (200 °C), referring to ATEX directive

HBRT 150 finishes (see page 9)

02 16 60	option 1	finishing set for direct entry into connection box silicone molded parts, adhesive technology, cable gland M20
02 17 05	option 2	factory-made finish with connection box
02 17 19	option 4	factory-made direct connection heating tape - power supply line (FEP cable)

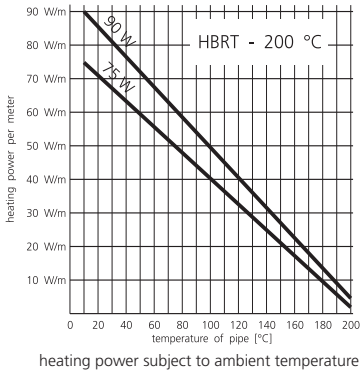
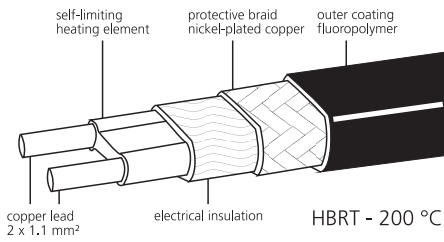

HBRT - 200 °C max. Ambient Temperature Self-Limiting Heating Tape

Technical Data

max. allowed ambient temperature: 200 °C energized, 250 °C de-energized
 nominal voltage: 230 V~
 min. bending radius: 30 mm
 breadth: 12.2 mm
 thickness: 5.2 mm
 protective braid: copper, nickel-plated
 outer mantle: fluoropolymer
 additional length for finishing: 130 mm
 humidity-proof

order no.	Watt/m	reference temp.	temperature class
02 15 43	75	10 °C	T2 (300 °C), referring to ATEX directive
02 15 46	90	10 °C	T3 (300 °C), referring to ATEX directive

order no.	HBRT 200 finishes (see page 9)
02 16 62	option 1 finishing set for direct entry into connection box silicone molded parts, adhesive technology, cable gland M20
02 17 07	option 2 factory-made finish with connection box
02 17 20	option 4 factory-made direct connection heating tape - power supply line (FEP cable) max. allowed ambient temperature: 180 °C

Finishes for Self-Limiting Heating Tapes

Option 1: Finishing Set for direct Entry into Connection box

Consisting of heat shrinkable tubing sections or silicone molded parts, small parts for the electrical connection and one cable gland M20 or M25 for the insertion of the heating tape into a suitable connection box. (Connection box not in scope of delivery, see page 10, "VTK")



pic. option 1: HBRT 120 finishing set for direct entry into connection box

Option 2: Factory-Made Finish with Connection Box

The heating tape is connected with cable glands to a robust rubber hose line in a high-quality, glass-fiber-reinforced plastic housing.

Housing dimensions: 110 x 110 x 67 mm, connection cable type H 07 RN-F 3 G 1.5



pic. option 2: ready-made finish with connection box and connection cable

Option 3: Finishing Set for direct Connection to Power Cable

According to the type of heating tape, appropriate technologies are used for the direct connection between heating tape and power supply line.

Power supply line: robust rubber hose, length 2 m

Option 4: Factory-Made Finish to Connection Cable

The heating tape is directly connected to a robust rubber cable or a FEP cable. Length: 2 m.

Please consider ordering additional heating tape length for finishing and if necessary for the distance from the component to be heated to the connection box!

Heating Tapes

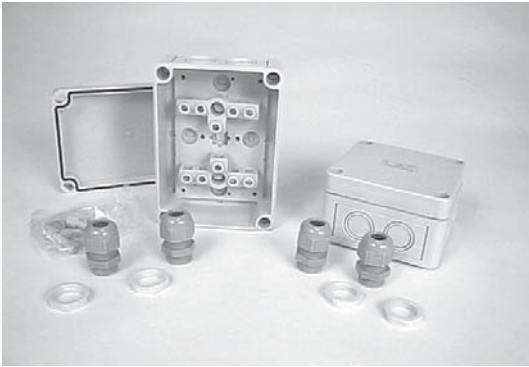

VTK 40 / VTK 50

Wall-Mounted Distribution Boxes

Including two cable glands (M 20) with lock nuts

Technical Data **VTK 40**

terminals: 5-pole clamped conn., 4x 4 mm²
 lead-through: 6x cable glands (M 20)
 dimensions: 93 x 93 x 55 mm
 material: polycarbonate, glass fiber reinforced
 prot. category: IP 65
 safety class: II
 order no.

VTK 50

2x 5-pole clamped conn., 4x 2.5 mm²
 10x cable glands (M 20)
 94 x 130 x 57 mm
 polycarbonate, glass fiber reinforced
 IP 65
 II

02 20 01	VTK 40
02 20 02	VTK 50



TR 1208

Wall-Mounted Anti-Freeze Regulator

Temperature regulator for use with self-limiting heating tapes. Switching function depends on ambient temperature and is triggered electromechanically through liquid expansion inside the measuring system.

Technical Data

set point range:	0 ... 40 °C	switching hysteresis:	± 0.75 K
nominal voltage:	230 V~	protection category:	IP 54 (EN 60529)
max. switching current:	16 A / 250V	sensor system:	membrane measuring
contact:	1 change-over contact	dimensions:	145 x 112 x 68 mm
ambient temperature:	-20 ... 50 °C	weight:	approx. 350 g

order no.

06 12 20	
06 12 21	accessory: protective grating for the capillary against mechanical damage

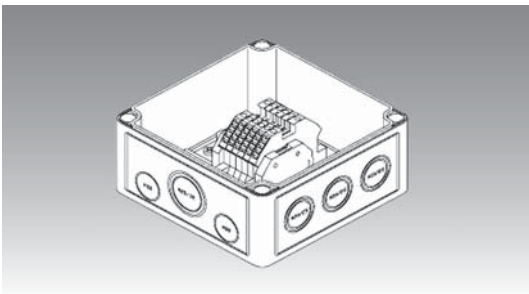

VTK 70

Connection Box

For the set-up of an electrical heating tape feed-in and connection. Up to four connections can be linked with internal terminals.

Technical Data

protection category: IP 65 (EN 60529)
 dimensions: 130 x 130 x 75 mm
 material: polycarbonate, glass fiber reinforced
 lead-throughs: 9x M20 / M25, 2x M20, 1x M25 / M32
 temperature resistance: -35 °C ... +75 °C
 terminals: Conta-Clip RK 2.5-4 on DIN mounting rail
 grounded conductor clamp: Conta-Clip SL 4 on DIN mounting rail
 conductor cross-section: 4 mm²

order no.

02 20 80	1x M25 cable gland for connection line included
----------	---

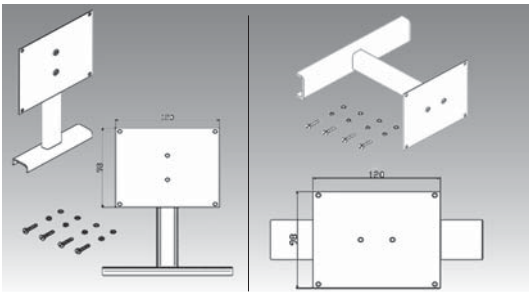

pic.: retaining foot VTH 80

pic.: retaining foot VTH 150

VTH

Retaining Feet for Connection Box VTK 70. Made of stainless steel (1.4301), mounting material included, without fastening clamps

order no.

02 20 85	retaining feet, small version, for distance plate – pipe: approx. 80 mm, weight: approx. 0.2 kg
02 20 86	retaining feet for distance plate – pipe: approx. 150 mm, weight: approx. 0.65 kg

VTB

Fastening Clamps for Connection Box for Retaining Feet, material: Stainless steel

order no.

02 20 87	VTB 50, for tube outer Ø 27 - 51 mm
02 20 88	VTB 120, for tube outer Ø 51 - 127 mm
02 20 89	VTB 300, for tube outer Ø 52 - 311 mm

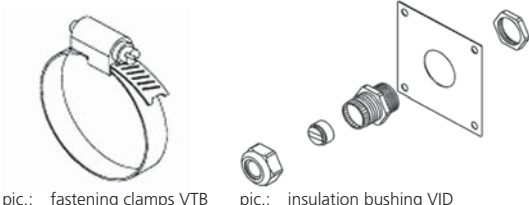

pic.: fastening clamps VTB

pic.: insulation bushing VID

VID

Insulation bushing for heating cable / supply cable. Contents: mounting plate, M20 cable gland, gasket

order no.

02 21 95	for HBRA / HBRC / HBRT heating tapes
----------	--------------------------------------

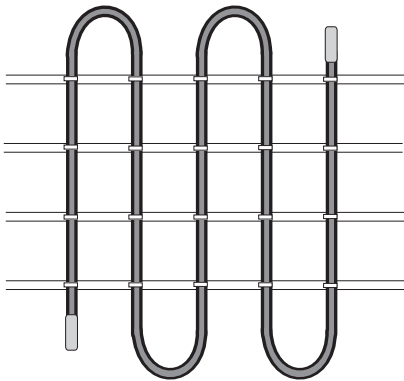

high malleability due to small bending radii

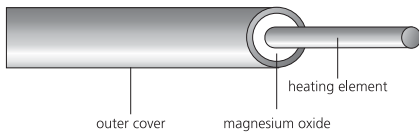

HSMV - 600 °C

Heating Cable with Special Steel Cover

Mineral-insulated heating cables can be used if generally high demands are made on the heating element. They are suitable for heating of pipes, containers, tanks, armatures and more. Mineral-insulated heating cables can also be integrated into the ground or into wall constructions made of concrete or similar materials.

They are suitable for anti-freeze as well as for the preservation or generation of process heat between 400 °C and 600 °C. If Inconel 2.4816 is used as mantle material, even higher temperatures are possible.

The main characteristics are:

- high mechanical strength
- waterproof, vacuum-sealed
- fireproof
- high heating power rates of several hundred Watt per meter heating wire
- operating temperatures up to 600 °C and higher
- small bending radius that allows a good processing with basic tools
- good corrosion resistance

Heating cables series HSMV can be operated in very corrosive areas due to the stainless steel mantle (1.4541). The heating wire inside is bedded in magnesium oxide to guarantee insulation towards the outer mantle. A great variety of resistance values allow the set-up of a wide range of heating cable lengths and operating voltages.

A soldered or welded sleeve (pic. 1) connects the heating cable to the cold end, also covered with a metal mantle. This homogenous heating construction leads to the connection box or into the switching cabinet. For the lead-through into the box, the heating cables are equipped with suitable metal cable glands M 20 × 1.5 (pic. 2).

The heating cables can be mounted either directly with tension bands on the parts to be heated, or on metal cuts or perforated plates, where the heating cables are layed in meandering shape.

Please give us your desired application and we will work out a suitable solution.

Available resistance values:

Ω/m	outer \varnothing [mm]	min. bending radius
10.00	3.2	> 15 mm
6.30	3.2	> 15 mm
4.00	3.2	> 15 mm
2.50	3.4	> 18 mm
1.60	3.6	> 18 mm
1.00	3.9	> 20 mm
0.63	4.3	> 20 mm
0.40	4.7	> 30 mm
0.25	5.3	> 30 mm

Following a selection of configured heating cables with standardized lengths and power rates. Other lengths and power rates on request.

Technical Data:

nominal voltage: 230 V~
 connection cable: 0.5 m
 protection category: comparable with IP 67
 safety class: I
 nominal temperature: 600 °C
 cable gland: M 20 × 1.5 (at end of connection cable)
 material: 1.4541

HSMV preconfigured (power: approx. 100 W/m):

order no.	power [W]	length [m]	\varnothing [mm]	min. bending radius [mm]
02 80 05	735	7.2	3.2	> 15
02 80 10	910	9.1	3.2	> 15
02 80 15	1150	11.5	3.2	> 15
02 80 20	1450	14.5	3.4	> 18
02 80 25	1800	18.0	3.6	> 18
02 80 30	2300	23.0	3.9	> 20
02 80 35	2900	29.0	4.3	> 20

HSMV preconfigured (power: approx. 200 W/m):

order no.	power [W]	length [m]	\varnothing [mm]	min. bending radius [mm]
02 80 60	1035	5.1	3.2	> 15
02 80 65	1300	6.5	3.2	> 15
02 80 70	1720	7.7	3.2	> 15
02 80 75	2060	10.3	3.4	> 18
02 80 80	2600	12.7	3.6	> 18
02 80 85	3410	15.5	3.9	> 20

Heating Tapes



HBS/HB - 450 °C / 350 °C

HBS - Smooth Heating Tape with Protective Braid

This versatile heating tape meets high requirements regarding heating power and operating temperature in a dry environment. It adapts perfectly, is flexible and consists of a multi-layer glass-yarn insulation and a metallic protective braid around the heating conductor, which is connected to the protective earth conductor.

HB - Heating Tape without Protective Braid for Small Radii

Due to the fact that it has no protective braid, the HB heating tape, which is otherwise identical to HBS, is particularly flexible and allows very small winding radii.

Technical Data

nominal voltage:	230 V~	not humidity-proof
connection cable:	0.5 m	with connection box (see p. 15)
thickness:	5.5 mm	
breadth:	30 mm	only HBS:
min. bending radius:	HB: 6 mm, HBS: 10 mm	protective braid:
		nickel

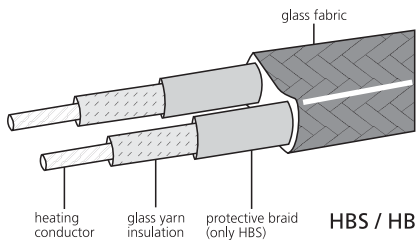

HBS

order no.	meter	watt	nominal temp.
02 03 01	0.5	100	450 °C
02 03 02	1.0	250	450 °C
02 03 03	1.5	350	450 °C
02 03 04	2.0	500	450 °C
02 03 05	2.5	600	450 °C
02 03 06	3.0	800	450 °C
02 03 11	4.0	900	450 °C
02 03 07	5.0	1250	450 °C
02 03 08	7.0	1550	450 °C
02 03 09	10.0	2000	350 °C
02 03 10	15.0	3000	350 °C

HB

order no.	meter	watt	nominal temp.
02 02 01	0.5	100	450 °C
02 02 02	1.0	250	450 °C
02 02 03	1.5	350	450 °C
02 02 04	2.0	500	450 °C
02 02 05	2.5	600	450 °C
02 02 06	3.0	750	450 °C
02 02 11	4.0	900	450 °C
02 02 07	5.0	1250	450 °C
02 02 10	6.0	1250	450 °C
02 02 08	7.0	1550	450 °C
02 02 09	10.0	2000	350 °C
02 02 12	15.0	3000	350 °C



HBQ - 900 °C

High Temperature Heating Tape without Protective Braid

The quartz-fiber insulation of this extremely smooth heating tape allows usage at very high temperatures in dry environments.

Technical Data

nominal temperature:	900 °C
nominal voltage:	230 V~
connection cable:	0.5 m
thickness:	5 mm
breadth:	30 mm
min. bending radius:	10 mm

no protective braid
not humidity-proof
with connection box (see p. 15)

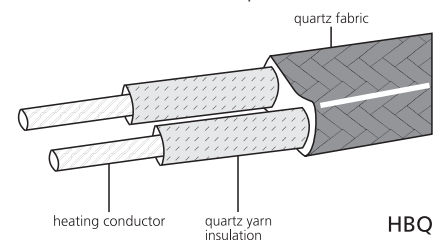

order no.	meter	watt
02 04 01	0.5	170
02 04 02	1.0	350
02 04 03	1.5	500
02 04 04	2.0	700
02 04 05	2.5	850
02 04 06	3.0	1000



HBV - 450 °C

Heating Tape with Outer Stainless Steel Protective Braid

Heating tape with multiple electrical glass-yarn insulation and protective braid made of 1.4301 (V2A), which is connected to the protective earth conductor. The close braiding minimizes the release of fibers.

Technical Data

nominal temperature:	450 °C	thickness:	5 mm
nominal voltage:	230 V~	breadth:	30 mm
connection cable:	0.5 m	protective braid:	nickel
min. bending radius:	10 mm	not humidity-proof	

with connection box (see p. 15)

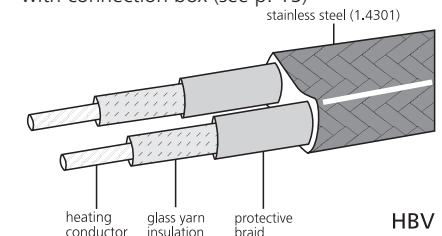

order no.	meter	watt
02 03 31	0.5	100
02 03 32	1.0	250
02 03 33	1.5	350
02 03 34	2.0	500
02 03 35	2.5	600
02 03 36	3.0	750
02 03 37	5.0	1250
02 03 38	7.0	1550



HBSI - 200 °C

Robust Silicone Heating Tape with High Heat Output

This flexible and hard-wearing heating tape combines a good heat transfer to surfaces with a high specific heat output.

Four parallel heating conductors are embedded in a silicone coating. Each individual heating conductor is electrically insulated with PTFE (250 °C max.) and has a metallic protective braid, which is connected to the protective earth conductor.

Technical Data

nominal temperature:	200 °C	protective braid:	copper, nickel-plated
nominal voltage:	230 V~	humidity-proof	
connection cable:	1.5 m	with connection box (see p. 15)	
min. bending radius:	20 mm		
thickness:	5 mm		
breadth:	24 mm		

order no.	meter	watt	order no.	meter	watt
02 06 01	0.8	125	02 06 08	4.0	400
02 06 02	1.0	100	02 06 09	5.0	500
02 06 03	1.5	70	02 06 10	6.0	600
02 06 04	1.7	235	02 06 11	10.0	1000
02 06 05	2.0	200	02 06 12	12.0	1200
02 06 06	2.8	320	02 06 13	15.0	970
02 06 07	3.0	300	02 06 14	20.0	2000

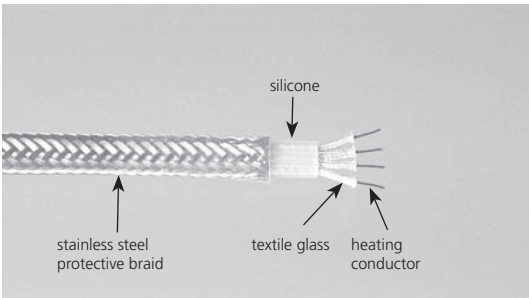
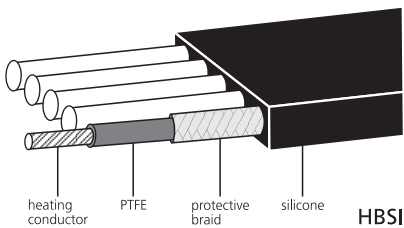

HBSIE - 200 °C

Slim Silicone Heating Tape

This silicone heating tape is only 12 mm wide and very flexible. Four parallel heating conductors, individually braided with textile glass, are embedded in a silicone coating. The construction has a metallic protective braid which is connected to the protective earth conductor.

Technical Data

nominal temperature:	200 °C	protective braid:	stainless steel
nominal voltage:	230 V~	operating insulation:	silicone
connection cable:	1.5 m	humidity-proof	
min. bending radius:	12 mm	with connection box (see p. 15)	
thickness:	6.4 mm		
breadth:	12 mm		

order no.	meter	watt	order no.	meter	watt
02 06 82	2.0	165	02 06 86	6.0	480
02 06 83	3.0	240	02 06 89	9.0	710
02 06 84	4.0	400			

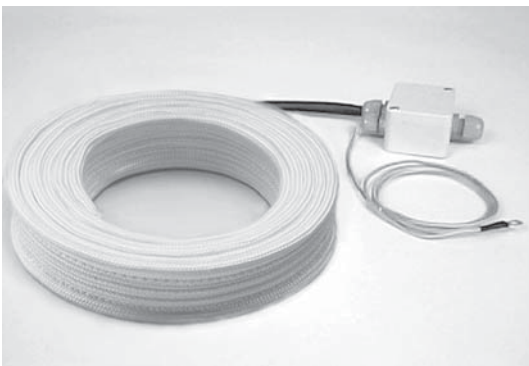
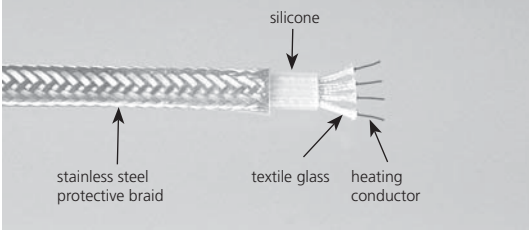

HBST - 250 °C

Heating Tape for Heat Conservation and Anti-Freeze

This heating tape available in lengths of more than 30 m has PTFE insulated heating conductors, covered with a metallic protective braid which is connected to the protective earth conductor. The heating conductors are inserted into a robust but flexible textile glass fabric.

Technical Data

nominal temperature:	250 °C	protective braid:	copper, nickel-plated
nominal voltage:	230 V~	humidity-proof	
connection cable:	1.0 m	with connection box (see p. 15)	
min. bending radius:	15 mm		
thickness:	5 mm		
breadth:	25 mm		

order no.	meter	watt	order no.	meter	watt
02 07 08	0.55	28	02 07 62	9.0	340
02 07 01	1.0	50	02 07 06	10.0	480
02 07 51	1.5	35	02 07 10	12.0	570
02 07 02	2.0	100	02 07 07	14.0	690
02 07 03	3.0	150	02 07 11	17.0	820
02 07 53	3.5	130	02 07 12	20.0	950
02 07 04	4.0	200	02 07 13	25.0	1200
02 07 05	5.0	250	02 07 14	29.0	1400
02 07 59	6.0	210	02 07 15	36.0	1800
02 07 09	7.0	350			

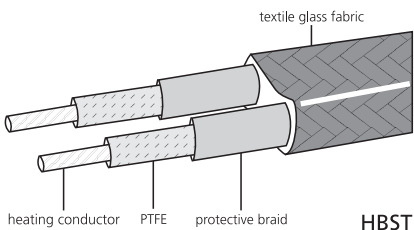

Heating Tapes

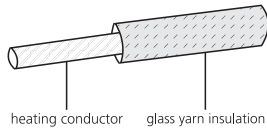
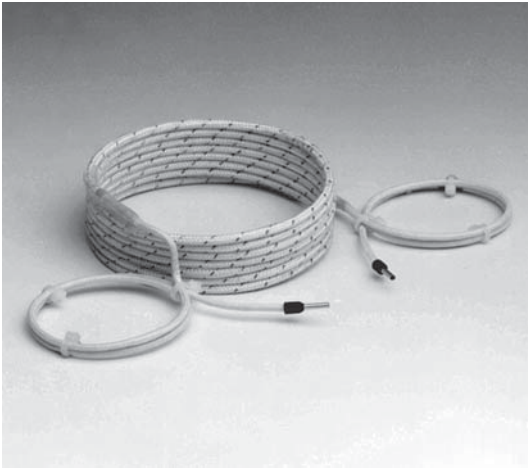

HS - 450 °C

Heating Cable with Very Small Winding Radius

This extremely flexible glass yarn insulated heating cable can be used for very small winding radii.

Technical Data

nominal temperature: 450 °C
 nominal voltage: 230 V~
 connection cable: 1.5 m
 min. bending radius: 4 mm
 diameter: 3 - 4 mm

no protective braid
 not humidity-proof



order no.	meter	watt
02 01 01	0.6	75
02 01 02	1.0	100
02 01 15	1.5	150
02 01 03	2.0	250
02 01 04	3.0	350
02 01 05	4.0	500
02 01 06	5.0	600
02 01 07	6.0	800
02 01 08	8.0	900
02 01 10	10.0	1250
02 01 12	15.0	1500

Other lengths and power ratings are available at short notice.

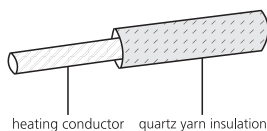

HSQ - 900 °C

Flexible Heating Cable with High Temperature Resistance

HSQ heating cables are insulated with quartz yarn and have high power rates per meter. They can be used at high temperatures and for small winding radii.

Technical Data

nominal temperature: 900 °C
 nominal voltage: 230 V~
 connection cable: 1.5 m
 min. bending radius: 10 mm
 diameter: 3.5 - 4.5 mm

no protective braid
 not humidity-proof



order no.	meter	watt
02 10 01	1.0	170
02 10 02	2.1	370
02 10 03	3.0	500
02 10 04	4.0	700
02 10 05	5.0	850
02 10 06	6.0	1000

Other lengths and power ratings are available at short notice.

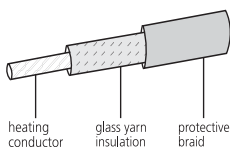

HSS - 450 °C / 350 °C

Heating Cable with Additional Protective Braid

This flexible heating cable is similar to type HS but has an additional protective braid, which is connected to the protective earth conductor.

Technical Data

nominal voltage: 230 V~
 connection cable: 1.5 m
 min. bending radius: 6 mm
 diameter: 3.5 - 4.5 mm

protective braid: nickel
 not humidity-proof



order no.	meter	watt	nominal temp.
02 09 01	0.6	75	450 °C
02 09 02	1.0	100	450 °C
02 09 03	2.0	250	450 °C
02 09 04	3.0	350	450 °C
02 09 05	4.0	500	450 °C
02 09 06	5.0	600	450 °C
02 09 07	6.0	800	450 °C
02 09 10	10.0	1250	450 °C
02 09 11	15.0	1500	350 °C

Other lengths and power ratings are available at short notice.

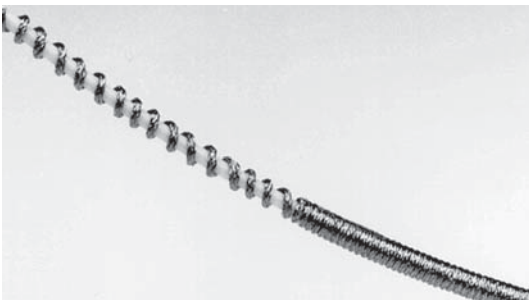
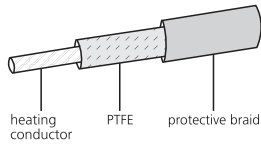

HST - 250 °C

Humidity-Proof Heating Cable with Small Diameter

This thin and very flexible heating cable is electrically insulated with PTFE and covered with a metallic protective braid, which is connected to the protective earth conductor. Available in lengths of 1 m up to more than 70 m, HST is suitable for a wide range of applications.

Technical Data

nominal temperature: 250 °C
 nominal voltage: 230 V~
 connection cable: 1.5 m PTFE cable
 min. bending radius: 10 mm
 diameter: 2.5 - 3.5 mm

protective braid: copper, nickel-plated
 humidity-proof

order no.	meter	watt	order no.	meter	watt
02 08 21	1.1	30	02 08 05	12.0	250
02 08 22	2.0	50	02 08 12	14.0	350
02 08 10	3.0	80	02 08 07	20.0	480
02 08 23	4.0	100	02 08 25	24.0	570
02 08 11	4.5	125	02 08 26	28.0	690
02 08 85	5.0	120	02 08 08	30.0	635
02 08 01	5.5	125	02 08 27	34.0	820
02 08 02	6.0	150	02 08 28	40.0	950
02 08 03	8.0	200	02 08 17	42.0	890
02 08 04	9.0	180	02 08 29	50.0	1200
02 08 24	10.0	250	02 08 30	58.0	1400
			02 08 31	72.0	1800

Other lengths and power ratings are available at short notice.

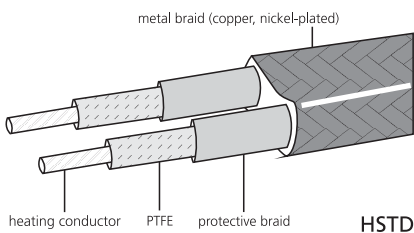
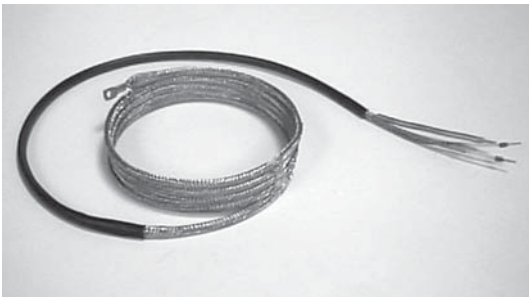

HSTD - 250 °C

Slim Heating Tape with High Specific Heat Output

The heating conductors of this slim heating tape are electrically insulated with PTFE and have a metallic protective braid. They are double-laid and inserted into an additional metallic braid, which is connected to the protective earth conductor.

Technical Data

nominal temperature: 250 °C
 nominal voltage: 230 V~
 connection: 1 m with wire end sleeves
 min. bending radius: 10 mm
 thickness: 4 mm
 breadth: 8-9 mm

protective braid: copper, nickel-plated
 humidity-proof

order no.	meter	watt	order no.	meter	watt
02 52 01	0.5	30	02 52 05	4.0	200
02 52 02	1.0	50	02 52 06	5.0	250
02 52 09	1.5	80	02 52 10	6.0	300
02 52 03	2.0	100	02 52 07	10.0	480
02 52 04	3.0	150			

Other lengths and power ratings are available at short notice.

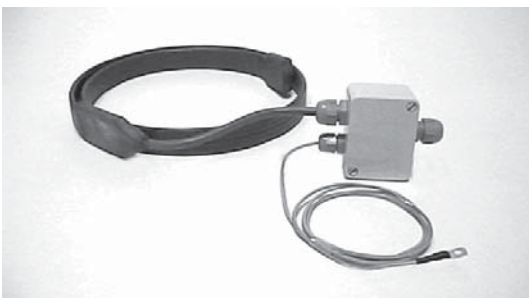

VTH

Connection Box for Heating Tapes

The clamps and cable glands of this connection box are specially designed for HBS, HB, HBQ, HBV, HBSI, HBSIE and HBST heating tapes and are in the scope of delivery. The connection box also can be used for HS, HSQ, HSS, HST and HSTD heating cables and ordered separately. According to VDE rules, there is a grounding connection for protective earthing of conductive objects and surfaces.

Technical Data

protection category: IP 65
 material: ABS
 dimensions (L x W x H) in mm: 65 x 55 x 35

order no. _____
 02 20 30

Heating Tapes

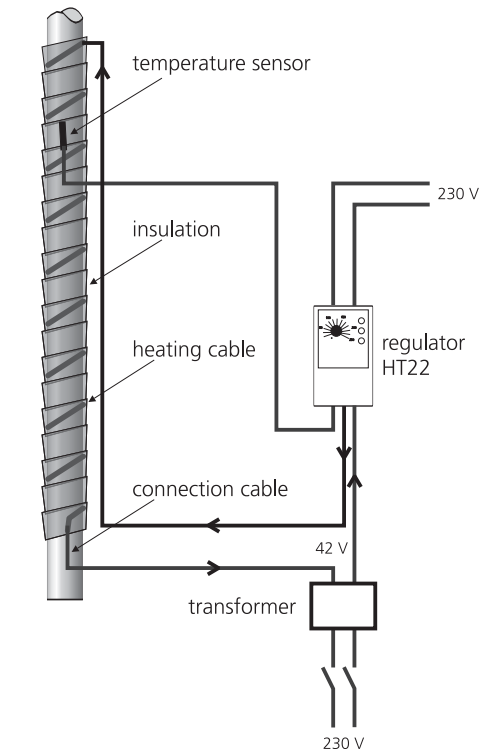

example: 42 V heating connected to a temperature regulator

Heating Cables for 42 V

For safety or technical reasons, it is often necessary to use a low-voltage electric heating. The 42 V heating cables listed below are similar to the 230 V types and also have excellent insulating properties.

HST 42 - 250 °C

Humidity-Proof Heating Cable for Low Voltages

order no.	meter	watt	order no.	meter	watt
02 32 01	0.4	8	02 32 08	4.5	110
02 32 02	0.7	20	02 32 09	5.0	125
02 32 03	1.0	30	02 32 10	6.0	150
02 32 04	1.5	40	02 32 11	7.0	175
02 32 05	2.0	50	02 32 12	9.0	225
02 32 06	2.6	65	02 32 13	10.5	260
02 32 07	3.8	90	02 32 14	13.0	320

HS 42 - 350 °C / 450 °C

Heating Cable for Low Voltages with Very Small Winding Radius

order no.	meter	watt	nom. temp.	order no.	meter	watt	nom. temp.
02 30 01	0.6	60	450 °C	02 30 06	2.3	210	450 °C
02 30 02	0.8	80	450 °C	02 30 07	2.7	270	450 °C
02 30 03	1.0	100	450 °C	02 30 08	3.5	350	450 °C
02 30 04	1.3	120	450 °C	02 30 09	3.8	360	350 °C
02 30 05	1.6	150	450 °C	02 30 10	5.7	520	350 °C

HSQ 42 - 900 °C

Flexible Heating Cable for Low Voltages with High-Temperature Stability

order no.	meter	watt	order no.	meter	watt
02 31 01	0.4	70	02 31 04	1.0	140
02 31 02	0.6	80	02 31 05	1.3	190
02 31 03	0.8	120	02 31 06	1.7	220

ST 100 - ST 300 - ST 500

Safety Transformer according to EN 60085 for Heating Cables with Nominal Voltage of 42 V

The safety transformers ST 100 and ST 300 with separate windings are required for heatings with nominal voltage of 42 V.

In case of short-circuit, these transformers are protected by an integrated thermal fuse and against overload by an exchangeable glass-tube fuse.

The power cable of the primary 230 V~ input has a flat plug which complies with the European Norm. The secondary 42 V~ consumer outputs are connected by clamps.

The transformers are molded in outer casings.

Please ask for further output currents or output voltages.

Technical Data	ST 100	ST 300	ST 500
type:	safety transformer according to VDE 0570 T2-6, EN60085		
input voltage:	230 V~	230 V~	230 V~
output voltage:	42 V~	42 V~	42 V~
nominal output:	100 VA	300 VA	500 VA
safety class:	II	II	II
outlet terminals:	1 pair	1 pair	1 pair
length connecting cable:	1.6 m	1.6 m	1.6 m
dimensions [mm]:	79 × 86.5 × 129.5	103 × 86.5 × 129.5	133 × 107.5 × 176.5
total weight:	2.5 kg	4.5 kg	8.5 kg
order no.	10 50 01	10 50 02	10 50 03



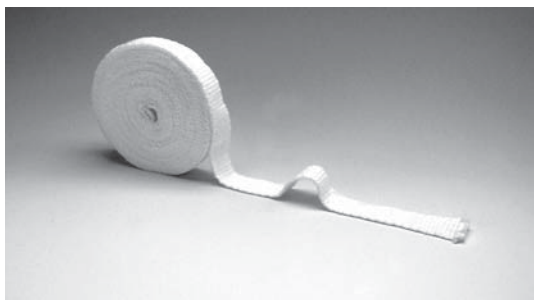

GCC - 1000 °C

Soft and fleecy staple-fiber tape (BCTEX fabric tape), suitable for taping and insulating heated sections, maximum operating temperature: 1000 °C

order no.	breadth	thickness	unit
10 02 11	50 mm	2 mm	25 m roll



GBB - 500 °C

Broad glass fiber tape for taping of heating cables, also suitable for large tubes and containers, maximum operating temperature: 500 °C

order no.	breadth / thickness	unit
10 02 02	70 mm / 0.7 mm	100 m roll

GBW - 450 °C

Fleecy glass fiber tape, approx. 3 mm thick for insulating heated sections

order no.	breadth	unit
10 02 01	25 mm	30 m roll



GB - 450 °C

Thin, adaptable glass fiber tape for taping and fixing heating conductors and temperature sensors, maximum operating temperature: 450 °C

order no.	breadth / thickness	unit
10 03 01	25 mm / 0.15 mm	50 m roll
10 03 02	15 mm / 0.15 mm	50 m roll

GSO - 450 °C

Glass fiber cord

order no.	diameter	unit
10 04 01	2 mm	running m
10 04 02	3 mm	running m

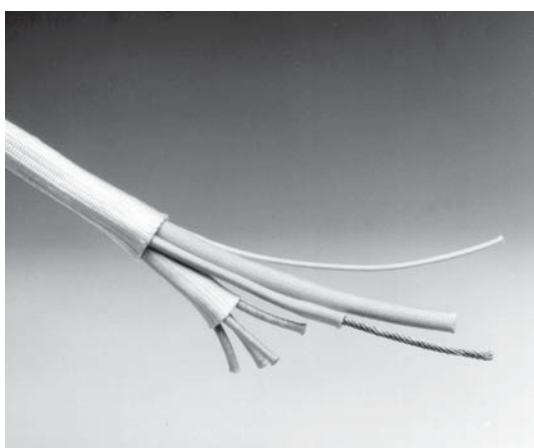

GSH - 450 °C

Glass fabric hoses for insulation of electric lines, max. temperature 450 °C

order no.	inner diameter	unit
10 05 05	2 mm	100 m
10 05 01	3 mm	100 m
10 05 02	6 mm	50 m
10 05 03	8 mm	50 m
10 05 04	13 mm	10 m

GSK - 900 °C

High quality quartz-glass-fabric hoses for insulating electric conductors, maximum operating temperature: 900 °C

order no.	inner diameter	unit
10 06 03	2 mm	10 m
10 06 01	4 mm	10 m
10 06 02	30 mm	5 m

GSI - 250 °C

Glass fabric hoses, surface coated with black silicone (mat), for insulation of electric lines, max. temperature 250 °C

order no.	inner diameter	unit
10 07 00	4 mm	running m
10 07 01	6 mm	running m
10 07 02	8 mm	running m
10 07 03	12 mm	running m



SJ - 200 °C

Waterproof silicone-foam hose with closed pores for insulating pipes and hoses. Operating temperature: up to 200 °C

order no.	inner diameter	insulation size	unit
10 16 05	15 mm	7.5 mm	running m
10 16 01	20 mm	10 mm	running m
10 16 02	25 mm	10 mm	running m
10 16 03	30 mm	10 mm	running m
10 16 04	40 mm	10 mm	running m
10 16 06	50 mm	15 mm	running m
10 16 07	80 mm	15 mm	running m

Mounting Accessories



Temperature-resistant fabrics for covering heated surfaces and thermal insulations

SSG - 450 °C

Glass-yarn fabric, operating temperature up to 450 °C

order no.	breadth	thickness	unit
10 19 01	1000 mm	1.35 mm	running m

SGI - 200 °C

Glass-yarn fabric, silicone-coated on both sides, max. operating temperature 200 °C, short-term 250 °C

order no.	breadth	thickness	unit
10 20 01	1500 mm	0.52 mm	running m

SGA - 160 °C

Glass-yarn fabric, coated with aluminum on one side, washable and heat-reflective

order no.	breadth	thickness	unit
10 21 01	1000 mm	0.45 mm	running m

SCC - 1000 °C

BCTEX fabric, comfortable to use. Max. operating temperature: 1000 °C

order no.	breadth	thickness	unit
10 21 11	1000 mm	1.8 mm	running m



MCC - 1000 °C

Soft and fleecy fiber mat (BCTEX fleece) for insulation and covering of hot surfaces. Maximum operating temperature: 1000 °C

Thermal conductivity [W/mK]: 0.068 at 200 °C; 0.108 at 400 °C; 0.407 at 950 °C

order no.	breadth	thickness	unit
10 18 08	1000 mm	8 mm	running m
10 18 11	1000 mm	13 mm	running m

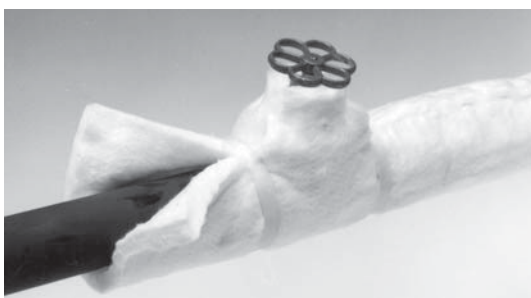

MG - 450 °C

Needled glass fiber mat for insulation of pipes and containers. Operating temperature: up to 450 °C

Thermal conductivity: 0.040 W/mK at 100 °C; 0.072 W/mK at 300 °C

order no.	breadth	thickness	unit
10 17 01	1000 mm	13 mm	running m

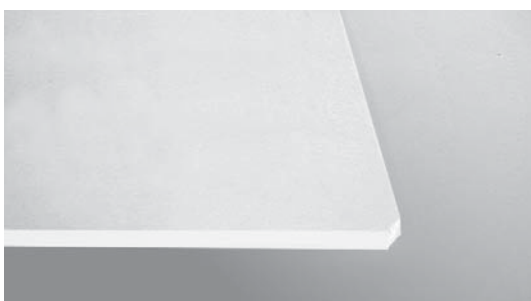

MSI - 200 °C

Silicone foam mat for temperatures up to 200 °C, 0.07 W/mK at 124 °C, color: light

order no.	breadth	thickness	length
10 17 50	1000 mm	5 mm	1000 mm
10 17 03	1000 mm	10 mm	1000 mm
10 17 49	1000 mm	20 mm	1000 mm

KSI - 150 °C

Silicone glue for operating temperature up to 150 °C

order no.	unit
10 01 10	tube, 310 ml

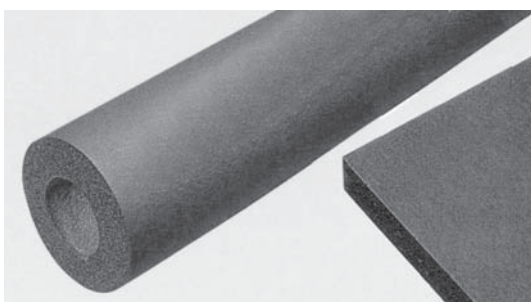

MEP

Insulating hose / insulating mat / self-adhesive insulation foam tape made of synthetic rubber with closed pores, color: black. Thermal conductivity: 0.040 W/mK at 40 °C.

order no.	inner diameter / type	thickness (+/- 1.5 mm)	unit	Temp. max.
10 17 05	13 mm ½ "	9.5 mm	length: 2 m	120 °C
10 17 06	25 mm 1 "	13 mm	length: 2 m	120 °C
10 17 07	38 mm 1½ "	11 mm	length: 2 m	120 °C
10 17 08	51 mm 2 "	11 mm	length: 2 m	120 °C
10 17 09	76 mm 3 "	11.5 mm	length: 2 m	120 °C
10 17 11	76 mm 3 "	40 mm	length: 2 m	120 °C
10 17 10	102 mm 4 "	12 mm	length: 2 m	120 °C
10 17 04	insulating mat	9 mm	size: 1 × 2 m	120 °C
10 17 14	insulating mat	19 mm	size: 1 × 2 m	120 °C
10 17 20	self-adhesive foam tape	3 mm	roll 15 m, breadth: 50 mm	90 °C



KSV - 100 °C

Velcro fastener, easy to use, for binding and fixing insulating jackets

order no.	breadth	unit
10 15 01	25 mm	10 m hook, 2 m loop

KSV - 180 °C

Velcro fastener for operating temperatures up to 180 °C, color: natural (white)

order no.	breadth	unit
10 15 02	25 mm	10 m hook, 2 m loop

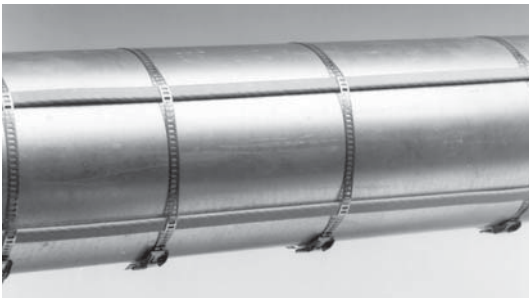

SP

Tension band for mounting plastic-insulated heating cables on pipes and containers with larger diameters

Material: 1.4301

order no.	breadth	unit
10 12 01	10 mm	10 m roll



SPV

Quick lock for SP tension band

Material: 1.4301

order no.	for tubes Ø	unit
10 12 02	35 - 60 mm	10 pcs.
10 12 03	> 60 mm	10 pcs.

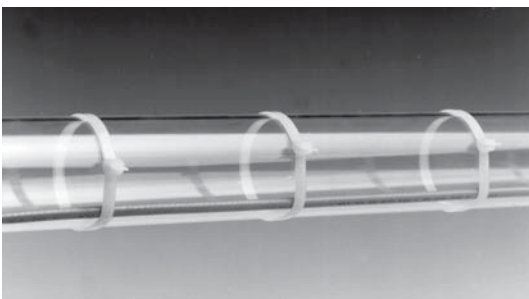

KSP - 105 °C / 150 °C

Thermoduric plastic binders for fixing heating cables and heating tapes

order no.	length / breadth	unit	max. working temperature
10 10 01	200 × 4.8 mm	100 pcs.	105 °C
10 10 02	360 × 4.8 mm	100 pcs.	105 °C
10 10 03	450 × 7.5 mm	100 pcs.	105 °C
10 10 04	150 × 3.6 mm	100 pcs.	150 °C
10 10 05	200 × 4.7 mm	100 pcs.	150 °C
10 10 06	389 × 4.8 mm	100 pcs.	150 °C

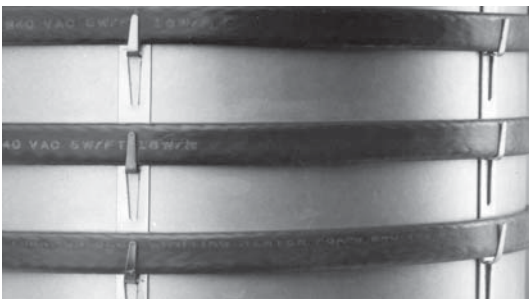

ABF

Spacer tape made of VA 1.4301 for the installation of heating tapes on containers. The spacer tape can be fixed by spot-welding or with tension bands.

Minimum spacing: 45 mm

order no.	unit
10 11 01	5 m



AB

Spacer tape for fixing plastic-insulated heating cables on plane or cylindrical surfaces. Minimum spacing: 15 mm

order no.	unit
10 09 01	running m

Mounting Accessories



HW

Information sign "electrical heating", self-adhesive, made of heat-resistant foil, printed in yellow and black.

Max. ambient temperature: 120 °C

order no.	size
10 01 51	75 × 51 mm
10 01 50	105 × 74 mm



KA

Porcelain clamps, operating temperature up to 250 °C

order no.	diameter	unit
10 25 11	1 × 2.5 mm ²	10 pcs.
10 25 12	2 × 2.5 mm ²	10 pcs.
10 25 13	3 × 2.5 mm ²	10 pcs.
10 25 14	4 × 2.5 mm ²	10 pcs.

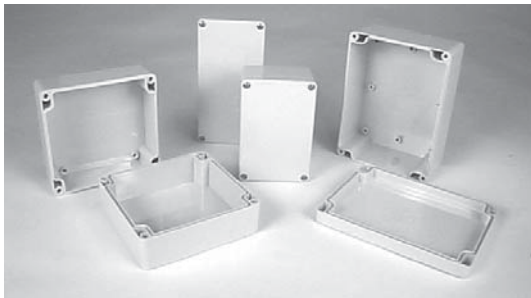

KG

Terminal box, protection category: IP 65 (EN 60529)

order no.	material	dimensions in mm
02 20 10	aluminum	58 × 64 × 36
02 20 11	aluminum	125 × 80 × 57
02 20 12	aluminum	175 × 80 × 57
02 20 20	ABS/Makrolon	120 × 80 × 41
02 20 21	ABS/Makrolon	120 × 80 × 55
02 20 22	ABS/Makrolon	122 × 120 × 75
02 20 23	ABS/Makrolon	160 × 80 × 55
02 20 24	ABS/Makrolon	160 × 120 × 75

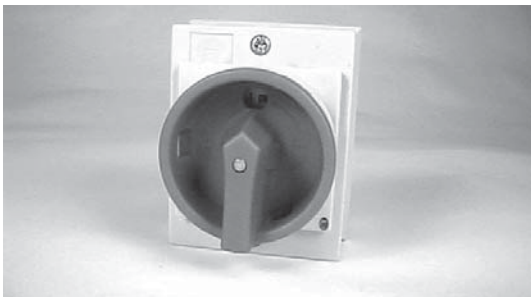

AS

3-pole circuit breaker according to EN 60947, VDE 0660

Technical Data

max. switchable voltage:	690 V AC
nominal constant current:	20 A
protection category:	IP 65
cable glands:	4 × M 20
case dimensions:	137 × 80 × 110 mm

order no.
06 90 20



FS

RCD (residual current protective device) available either as intermediate connector or for permanent connection to device lines or extension cables. Plug according to IEC 61540. Nominal triggering current 30 mA (fault current), all-pole cut off, undervoltage trip, 16 A 230 V~.

order no.	type
06 90 30	permanent connector to device lines or extension cables
06 90 31	intermediate connector



TS

Thermal switches for very basic control systems and temperature monitoring.

Technical Data

breaking capacity:	max. 10 A (2300 W)
number of switching actuations:	approx. 10,000 switching cycles
switch-off point:	nominal switching temperature ± 5 K
reclosing point:	approx. 30 ± 15 K below the switch-off point

order no.	nominal switching temperature	order no.	nominal switching temperature
07 07 04	60 °C	07 07 01	140 °C
07 07 07	80 °C	07 07 03	160 °C
07 07 02	100 °C	07 07 05	200 °C
07 07 08	120 °C	07 07 06	245 °C

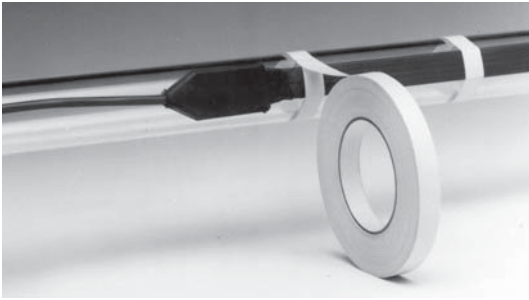

GKB - 155 °C

Glass fabric adhesive tape with acrylate glue for fixing heating tapes, heating cables and temperature sensors. Max. operating temperature 155 °C

order no.	breadth	unit
10 01 01	15 mm	50 m roll

GIB - 200 °C

High-quality glass fabric adhesive tape with silicone glue, suitable e.g. for mounting heating cables up to 200 °C.

order no.	breadth	unit
10 01 02	15 mm	50 m roll

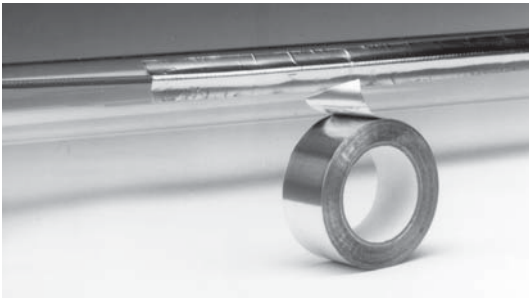

GAB - 120 °C

Heavy aluminum-foil tape with acrylate glue (hardening). Must not be used in direct contact with electrically, fiber-insulated heating cables and tapes. Aluminum guarantees a perfect heat transfer and distribution.

order no.	breadth / thickness	unit
10 01 03	50 mm / 0.13 mm	55 m roll
10 01 07	25 mm / 0.10 mm	25 m roll

SIB - 180 °C

Self-fusing silicone rubber tape

order no.	breadth / thickness	unit
10 01 16	25 mm / 0.5 mm	9.1 m roll

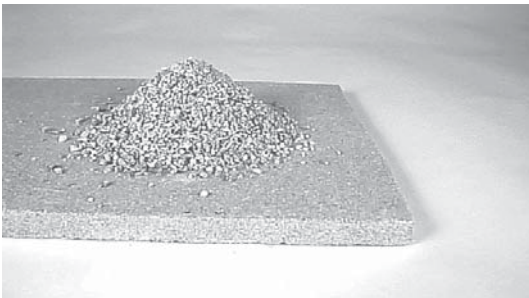

IM

Insulating Plates / Bulk Material - 1100 °C

This insulating material on Vermiculite basis is used to avoid heat loss. Plates for surfaces can be mechanically processed without any problems. Hollow spaces requiring heat insulation can be filled with bulk material. Physiologically harmless despite high operating temperature!

order no.	type	unit
10 21 51	insulating plate	1000 x 500 x 20 mm
10 21 55	insulating bulk material	100 l



NIL - 180 °C

Nickel connecting wire with silicone-glass-yarn insulation for wiring at temperatures up to 180 °C.

For temperatures higher than 180 °C, a GSH or GSK high temperature hose can be used as additional insulation.

order no.	diameter	unit	working insulation
10 24 01	0.75 mm ²	10 m	silicone / glass yarn
10 24 02	1.50 mm ²	10 m	silicone / glass yarn
10 24 03	2.50 mm ²	10 m	silicone / glass yarn

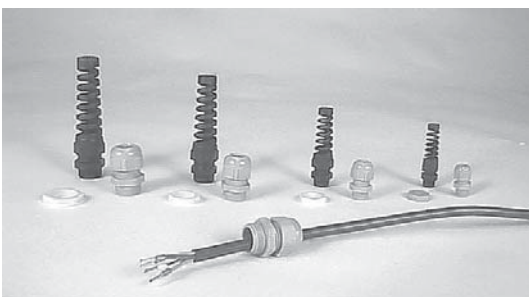

KC

Cable glands made of polyamide with lock nut, according to DIN VDE 0619, protection category: IP 68, for temperatures between -20 °C and +80 °C.

with anti-kink					without anti-kink	
order no.	size	for cable Ø	core hole Ø	thread size Ø	order no.	
10 26 11	M 12	3.5 - 7 mm	10.5 mm	12 mm	10 26 01	
10 26 12	M 16	4.5 - 10 mm	14.5 mm	16 mm	10 26 02	
10 26 13	M 20	7 - 13 mm	18.5 mm	20 mm	10 26 03	
10 26 14	M 25	9 - 17 mm	23.5 mm	25 mm	10 26 04	
10 26 15	M 32	11 - 21 mm	30.5 mm	32 mm	10 26 05	



SH - 250 °C

PTFE heat shrink tubings, shrinking rate: 4:1

order no.	type	inner diameter	wall thickness after shrinking
10 05 20	PTFE heat shrink sleeve ¼"	6.35 mm	0.30 mm
10 05 21	PTFE heat shrink sleeve ½"	12.70 mm	0.38 mm
10 05 22	PTFE heat shrink sleeve 1"	25.40 mm	0.38 mm

Heating Mats

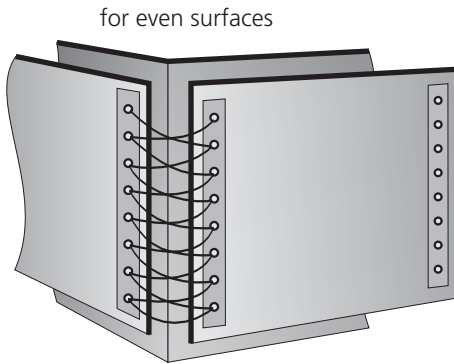

for pipes and round containers

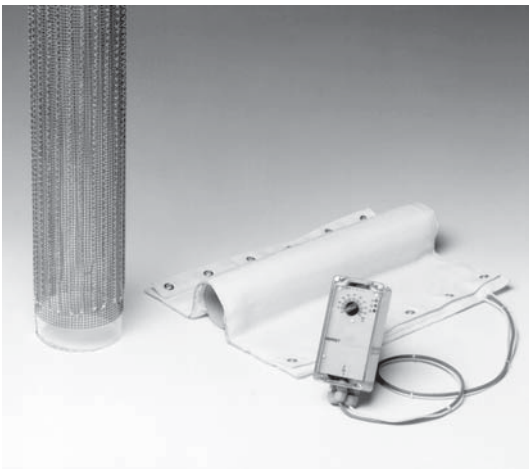
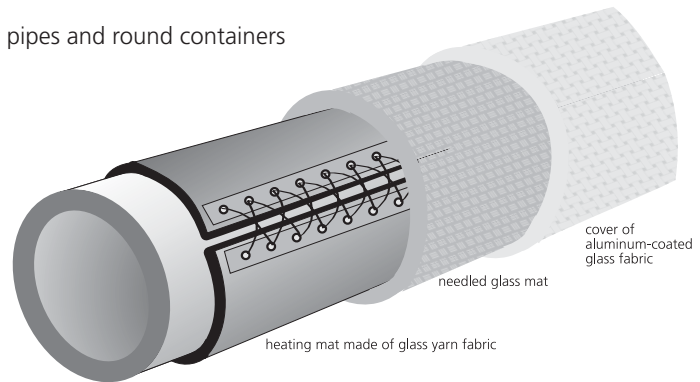

Heating Mats

Very flexible heating mats can be used on even surfaces and also for cylindrical containers and pipes. For the temperature regulation, each heating mat is equipped with a NiCr-Ni temperature sensor. The temperature-resistant connection line has a length of 1 m.

All heating mats are 500 mm long; the breadth depends on the diameter of the pipes. Deliverable at short notice.

size/inch	DN	breadth (mm)	length (mm)	HMST	HMSG	HMSQ
1	38	135	500	50 W	250 W	500 W
2	70	235	500	150 W	500 W	1000 W
3	108	355	500	250 W	1000 W	2000 W
4	159	515	500	350 W	1200 W	2400 W
5	205	660	500	500 W	1600 W	3200 W
6	256	820	500	690 W	2000 W	

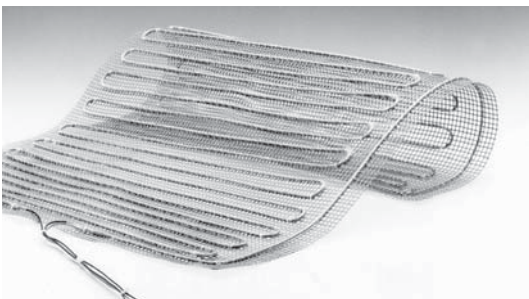

HMST - 250 °C

A PTFE coated mesh is the basis of this heating mat. The heating conductors are insulated with PTFE and have a protective braid. The mat can be fixed around containers and pipes with velcro fasteners (accessories).

Nominal temperature: 250 °C

order no.	size	order no.	size
03 50 01	1	03 50 04	4
03 50 02	2	03 50 05	5
03 50 03	3	03 50 06	6



HMSG - 450 °C

HMSG is a very flexible heating mat made of glass fiber fabric with nominal temperature of 450 °C. The glass-yarn-insulated heating conductor is covered with glass fiber fabric. Lengthways, the heating mat has eyelets for fixing with glass fiber cords (accessories).

order no.	size	order no.	size
03 60 01	1	03 60 04	4
03 60 02	2	03 60 05	5
03 60 03	3	03 60 06	6

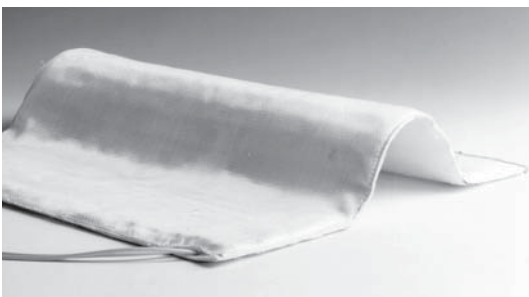

HMSQ - 900 °C

This flexible heating mat is made of high-quality quartz fiber fabric and has a nominal temperature of 900 °C. It can be fixed on pipes and containers with high-temperature-resistant cords (accessories).

order no.	size	order no.	size
03 70 01	1	03 70 04	4
03 70 02	2	03 70 05	5
03 70 03	3		

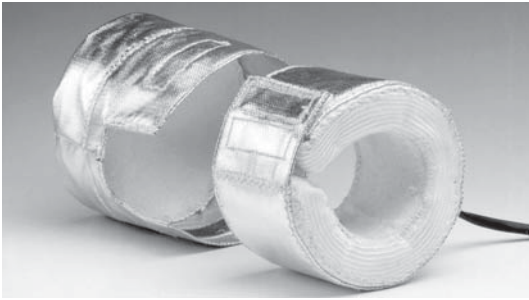

HFH / HFB - 350 °C

Flange Heatings

HFH and HFB for flanges on pipes and containers can be used for heating or compensation of heat loss. Available for all common flanges. Velcro fasteners allow easy mounting / demounting.

The heating surface is glass-yarn-insulated, the mantle consists of aluminum-coated glass fiber fabric. Front sides of blind flanges can be closed with an additional insulation cap, easily fixed with velcro fasteners.

Technical Data

nominal temperature: 350 °C
 nominal voltage: 230 V~
 connection: silicone-insulated connection line with wire end sleeves
 no protective earth
 not humidity proof

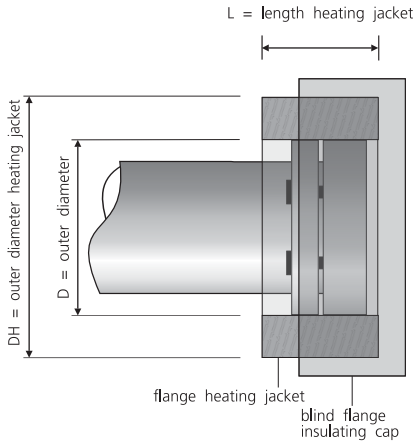

flange heating jackets

HFH

order no.	type	outer-Ø flange D (mm)	outer-Ø heating DH (mm)	length heating L (mm)	power at 230 V~ (watt)
03 40 01	HFH 16	33.8	93	25	8 (42 V)
03 40 02	HFH 35	69.5	129	50	40
03 40 03	HFH 63	113.5	173	60	65
03 40 04	HFH 100	152	212	75	90
03 40 05	HFH 150	202.5	262	75	140
03 40 06	HFH 200	253	313	80	180
03 40 07	HFH 250	306	366	80	220

blind flange insulating caps

HFB

order no.	type
03 45 01	HFB 25
03 45 02	HFB 35
03 45 03	HFB 63
03 45 04	HFB 100
03 45 05	HFB 150
03 45 06	HFB 200
03 45 07	HFB 250



HMI - 200 °C

Flexible Silicone Heating Mats, Splash-Proof

Silicone heating elements can be used for surfaces and cylindrical bodies. They are produced according to customer requirements and with heater power rates adapted to the respective application. They are very flexible and available in many different shapes and sizes. Boreholes and cut-outs are possible.

As a result of the specific power distribution, very even or individual temperature profiles can be realized.

Available as foils, mats or formed parts they offer an economic solution for many heating tasks.

Optional, integrated temperature sensors and thermal switches are available.

Technical Data

nominal temperature: 200 °C
 nominal voltage: 230 V~, 115 V~, 42 V~ and others
 min. ambient temperature: -60 °C
 surface power: max. 1 W/cm², higher values are possible after technical clarification
 thickness heating element: approx. 3 mm standard, min. 1 mm
 max. dimensions: 940 mm × 3000 mm
 material: silicone, silicone-coated glass braid
 fixing options: glueing, binding, velcro, pressing-on
 temperature sensor: vulcanized or in sensor pocket
 thermal insulation (optional): 4/8 mm, max. 40 mm

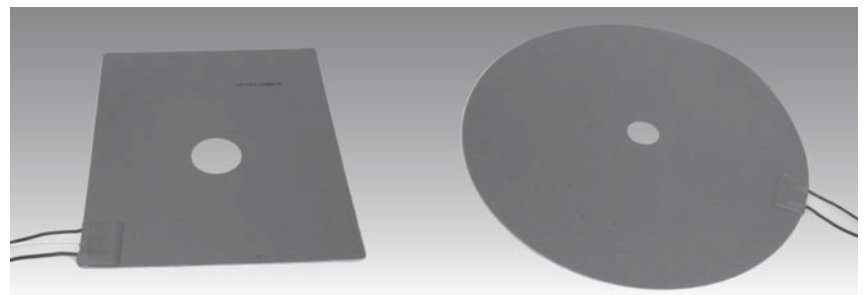
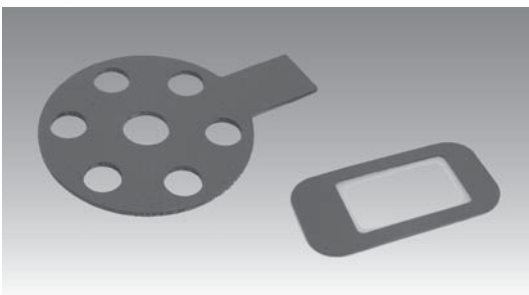

Heating Jackets



pic. 2



pic. 1

HMT - Heating Jackets

Application of Heating Jackets

Heating jackets are operational electric heatings with integrated thermal insulations. They are produced according to customer-specified shapes and can be used directly after quick and easy installation.

Heating jackets can be made for many different components:

- tubes (pic. 2)
 - flanges
 - distillation columns
 - portable containers (pic. 1)
 - casings of exhaust gas outlets (pic. 3)
 - tank bottoms (pic. 4)
 - standard vacuum components (pic. 5)
 - pump heads (pic. 7)
 - round or square containers
 - vacuum pumps (pic. 8)
 - flow measuring devices (pic. 6)
 - sample gas distributors (pic. 9)
 - valves
- and many other parts.



pic. 3

Heating jackets are made of textile materials. They consist of a heating surface, electrically insulated heating conductors, a thermal insulation and a robust outer braid. They can be fixed easily with velcro fasteners.

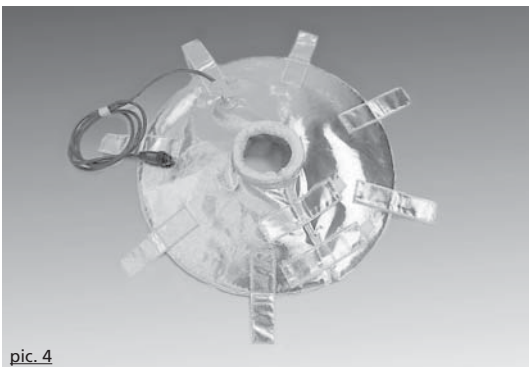

pic. 4

Materials

The materials are chosen corresponding to the conditions of use. Selection criteria are the operating temperature and the working environment where the heating is to be used.

High-quality technical fabrics such as kevlar, silicone, PTFE, textile glass and textile quartz glass are selected.

For temperatures up to 250 °C moisture-resistant, PTFE insulated heating conductors are suitable.

Up to 450 °C we use textile-glass-insulated heating conductors, up to 900 °C quartz-glass-insulated heating conductors.

We have a wide range of heating conductors in stock. With their small bending radii they can be attached closely even on complicated surfaces to be heated.

Homogeneous heating capacity reduces the strain on the heating conductor, and the temperature difference between the heating element and the intended temperature of the heated component is minimized.

The heat is distributed evenly over the available surface, not concentrated on certain points.



pic. 5



pic. 6

Temperature Control

Heating jackets must be operated temperature-controlled and, if necessary, with an additional temperature limiting device.

Our heating jackets are usually equipped with built-in thermocouples or Pt 100 resistance thermometers.

It is also possible to install thermal switches.

We recommend our series HT MC11 as an all-purpose temperature regulator (see page 48), for extensive heatings our series HT 61 (see page 54).

Lay-Out of a Typical Heating Jacket

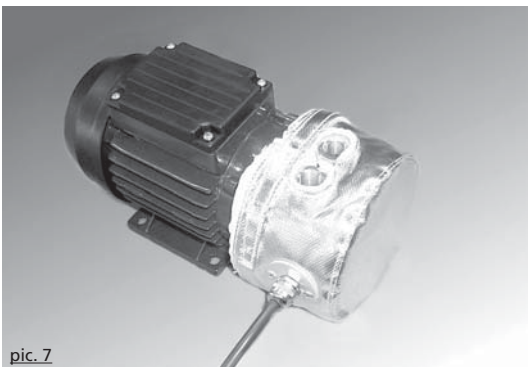
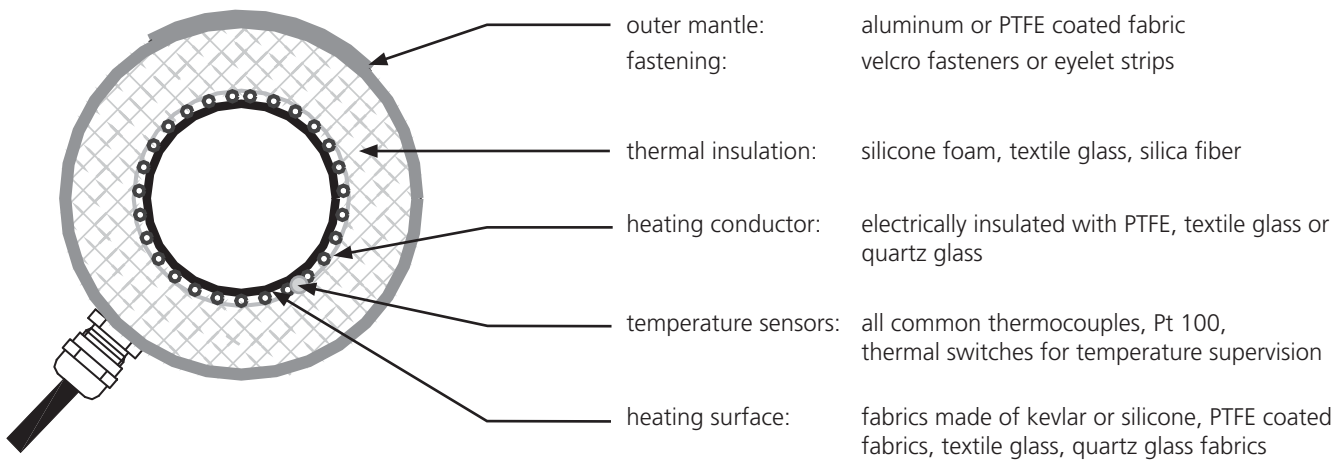

pic. 7

For a quotation, please provide the following information:

- description dimensions of the component to be heated, with drawing or photo
- function of the heating: heating-up of the component or compensation of heat loss
- operating temperature
- temperature sensor: standard is NiCr-Ni (K)
- heating jacket connection: net and sensor cable together or separate
- length of the connecting cable: standard is 1.5 m

Also jackets without heating elements are available.

These high-quality detachable and well-fitting insulating jackets protect heated components against undesired heat loss (see page 26).



pic. 8

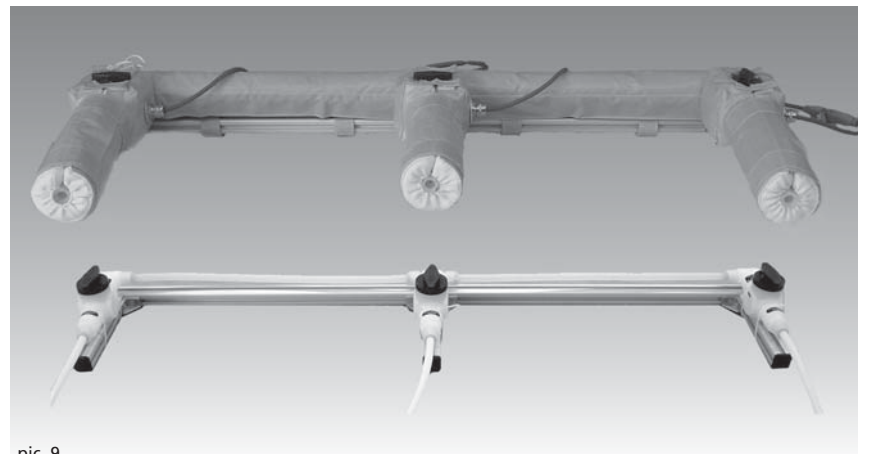

pic. 9

Insulating Jackets

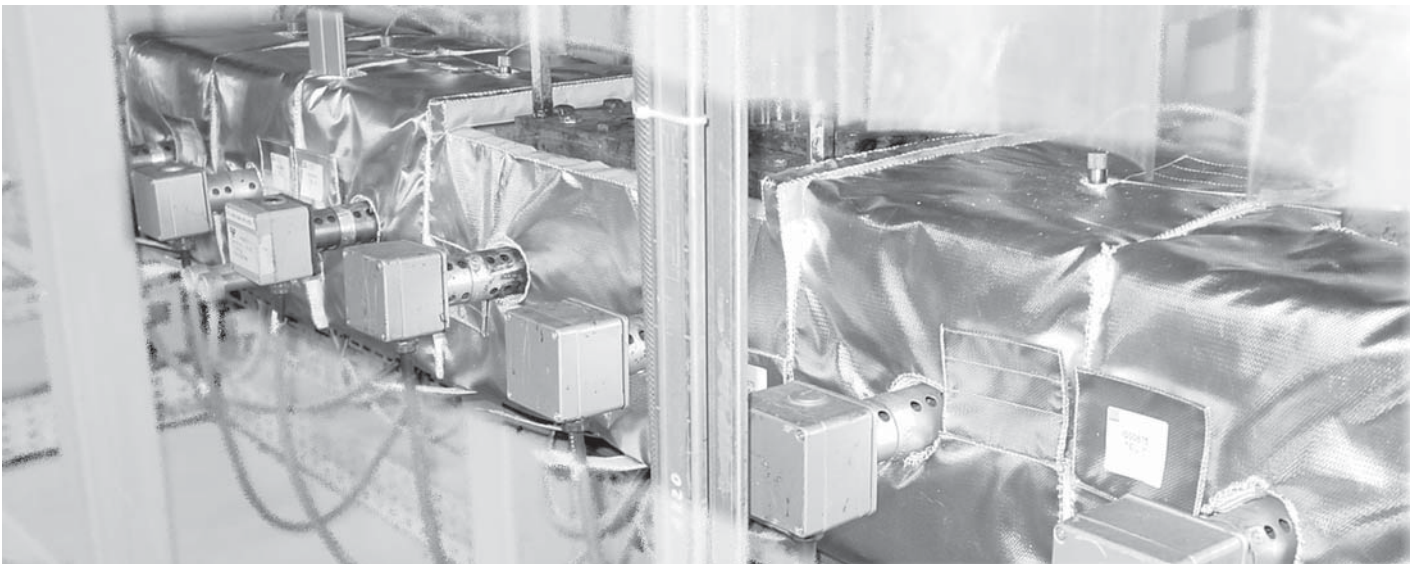
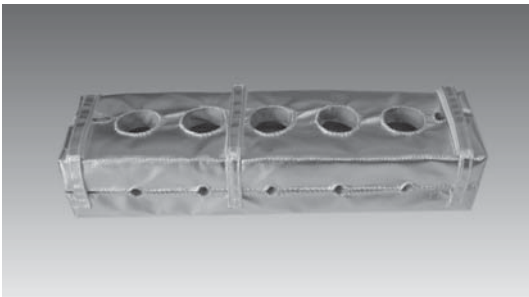
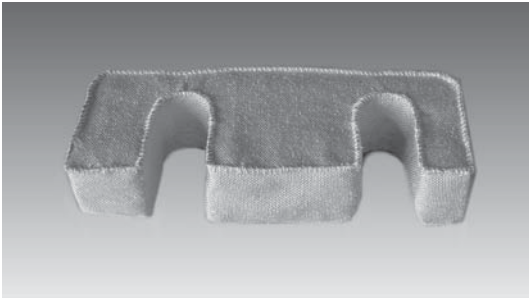
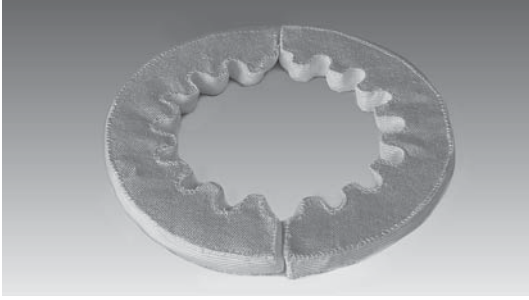

ISM

Thermal Insulating Jackets for -50 °C ... 1000 °C

These insulating jackets are often applied in the field of high-quality plant engineering, where a professional design is important. Suitable for industrial use, they e.g. can insulate subsequently extruders in the plastics industry. Insulating jackets are designed to fit complicated components, considering individual heatings, sensors and fittings. Due to the heat insulation, the radiation is reduced, the efficiency of the heating increased, energy saved and hot surfaces are protected from accidental touch. HORST produces high-quality heat insulations for a wide range of geometries according to samples or drawings. The applied materials are selected to the requirements of the application.

The following materials are used depending on the surface temperatures:

- up to 100 °C: aluminum-coated textile glass fabric
 - up to 200 °C: silicone-coated textile glass fabric
 - up to 250 °C: PTFE coated textile glass fabric
- These materials are fiber-free and suitable for applications in clean environments.
- For temperatures higher than 250 °C we recommend the use of textile glass materials in appropriate qualities for applications up to 450 °C, 650 °C and 1000 °C.

Heat insulation materials:

- up to 120 °C: foamed EPDM plate materials (fiber-free)
- up to 200 °C: foamed silicone (fiber-free)
- up to 450 °C and 1000 °C: fiber materials

Besides the good technical characteristics, we consider health aspects when selecting materials. The needed structure of the mats guarantees stability without additional chemical binding materials.

The insulation layer is manually integrated between two fabric layers. Therefore, the defined insulation thickness is kept also up to the edges.

Velcros or bindings with hooks and eyelets allow convenient fixing.

Please send us your request with a description of your insulating task.



HFI 20 barrel insulating jacket

pic.: barrel insulating jacket HFI 20 in combination with mounted barrel heating rings

Barrel Heating

These heating elements are perfectly suitable for 200 L DIN barrels for heating on-site. The temperature of each heating element can be individually adjusted between 30 °C and 110 °C. For safe and economic operation, depending on the required power, one barrel head heating (1300 W) and up to three barrel heating rings (1400 W each) can be used.

HFI 20

Barrel Insulating Jacket

Robust, high-quality insulation for 200 L DIN barrels. Simple mounting with velcro fasteners and hooks.

order no.	nominal temperature	material outer mantle
20 30 01	120 °C	Preox/Aramid fabric
20 30 03	160 °C	glass/alu fabric



HM 20 K

Robust Barrel Heating Ring

The inside and the outside of this barrel heating ring is made of sheet aluminum. This protects the electrical components against mechanical damage.

A hinge joint divides the heating ring into two half shells, allowing convenient mounting without bending the heating element.

Integrated thermal insulation increases the effectiveness and decreases the temperature on accessible surfaces.

The temperature of the heating surface is adjustable with a mechanical built-on aluminum housing. The temperature of the heating surface can be adjusted with a mechanical thermostat built in the attached aluminum terminal box (30 – 110 °C). As a protection against over-temperature of the heating surface, a thermal switch and a thermal fuse are integrated in each half shell, in addition to the regulator.

Technical Data

inner Ø × height:	570 × 230 mm	temperature range:	30 °C ... 110 °C
nominal voltage:	230 V~	nominal power:	1400 W
safety class:	I	protection category:	IP 65 (EN 60529)
connection:	2 m rubber power line with safety plug		

order no. _____
20 20 20

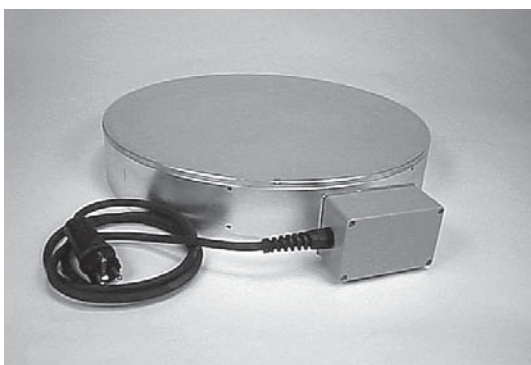

HB 20 K

Heavy and Solid Barrel Head Heating Plate

The aluminum and galvanized steel construction remains fully functional even under difficult operating conditions. The temperature regulation is installed in an aluminum casing. The temperature of the heating surface can be adjusted from 30 °C to 110 °C.

Technical Data

dimensions:	520 × 88 mm	temperature range:	30 °C ... 110 °C
nominal voltage:	230 V~	nominal power:	1300 W
safety class:	I	protection category:	IP 65 (EN 60529)
power supply:	2 m rubber power line with safety plug		

order no. _____
20 22 05

Tube Furnaces

HMF

Customized Tube Furnaces for Operating Temperatures 50 °C - 1000 °C

Horst tube furnaces are made of standardized components according to customer's requirements.

Each appliance is constructed considering the individual technical demands.

Examples:

- standard desktop model with detachable stand and protective barrier (pic. 1 and 3)
- reactor heating, integrated in a production plant or test set-up. Picture 2 shows a model on a running rail with counterweight for easy positioning
- three-part tube furnace on a sliding rail (photo on page 3)
- heating in portable calibrating devices
- built-in model for 19" casings
- stationary model for use in combination with eight inserted furnaces, water-cooled to minimize heat radiation (pic. 4)
- hinged furnace with glass fabric heating surface. The example in picture 5 has three heating zones for optimal temperature distribution over a length of 600 mm

All tube furnaces provide short heating-up times and homogenous heat distribution. This is achieved by using electrically-insulated heating conductors, which allow a narrow winding round the tube. The total power is distributed on the longest possible heating conductor in order to keep the surface load low.

Each tube furnace can be used in a vertical or horizontal position and has a built-in thermocouple.

Tube furnaces must be used in combination with a temperature regulator. You can either use an available control device or choose a matching regulator from our product range, e.g. HT 30 (page 44) or HT MC11 (page 48).

For a quotation, please provide us with a description of the application and the following specifications:

	<u>options</u>
inner tube diameter:	3 - 120 mm
inner tube material:	heat-resistant stainless steel, quartz glass, ceramic
heated length:	50 - 1000 mm
operating temperature:	50 - 1000 °C, max. 800 °C with metallic inner tubes
temperature sensor:	NiCr-Ni, Pt 100, others
heating zones:	as required, depending on the heated length
nominal voltage:	12 - 400 VAC

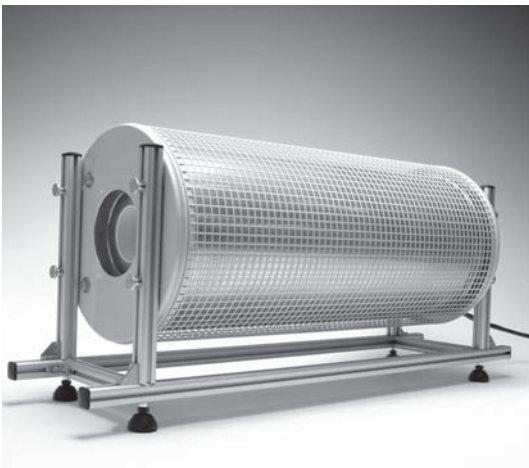

pic. 1



pic. 2



pic. 3

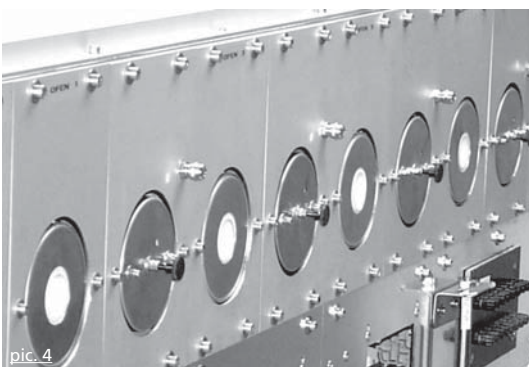

pic. 4

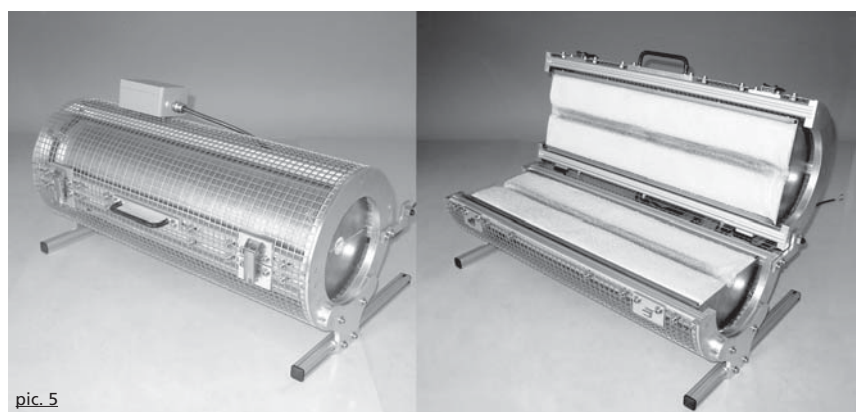

pic. 5

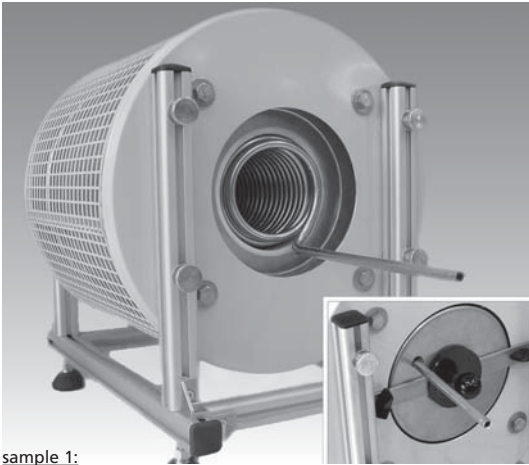

sample 1:



sample 2:

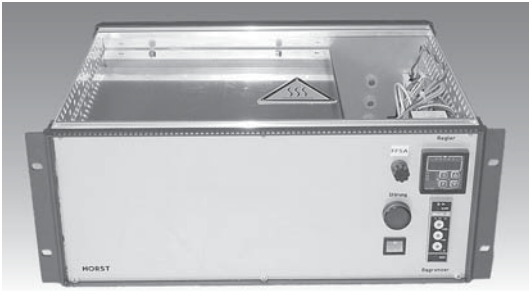

sample 3:

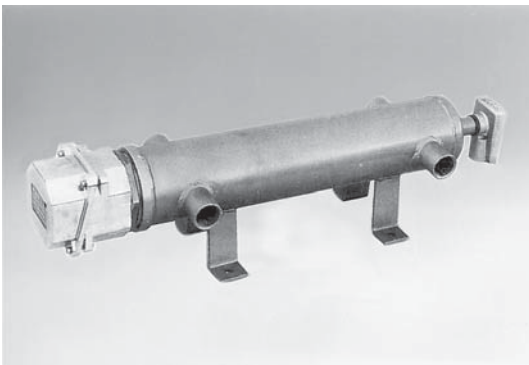

VG

Gas Heaters for Small Flow Rates up to 900 °C

This heating appliance is suitable for heating non-combustible gases with flow rates < 10 m³/h. Outlet temperatures up to 900 °C can be reached.

All VG models have heating elements situated outside the pipe, which the medium flows through.

- Depending on the flow rate, pipe diameters of 4, 6 or 8 mm can be chosen
- Pipe materials like temperature-resistant stainless steel, nickel and chrome alloys or even glass and quartz glass can be applied.
- To optimize the heat transfer, the pipes are formed in a spiral or meander shape. The heating element is adapted to the application regarding design and heater power.

Each heater is individually customized, considering the demands of applied materials, flow rate, target temperature and installation situation.

Sample 1: A basic way to heat gases is to insert a spiral into the electrically-insulated heating pipe of a tube furnace (also see page 28). The front is closed. VG gas heaters can be implemented for a wide range of uses. A separate temperature regulation is required, e.g. HT MC11 (see page 48).

Sample 2: Heater unit and controller are integrated in a compact housing. Medium inlet and outlet are on the front. The temperature regulation and an additional temperature limiter are combined with further components such as main switch, fuse and ventilator.

Sample 3: The control of this gas heater is similar to sample 2. The housing is designed as a 19" rack for integration into a measuring cabinet. Medium inlet and outlet are on the back.

Please give us your desired application and we will work out a suitable solution.

GA

Circulation Heaters

Liquids and gases with a continuous flow can be heated effectively with compact circulation heaters.

Construction: A heating element is placed in a flow tube from the front. The exchangeable heating element is sealed with threads or flanges. The medium is led into the flow tube, passes the heating element and exits heated.

Temperature control: Circulation heaters require separate temperature regulators. One regulator controls the outlet temperature of the medium, a second regulator limits the temperature of the heating element.

Quotation: For a quotation an exact technical calculation is important. Please describe your planned application and specify medium, volumetric flow-rate, inlet temperature, operating pressure and desired outlet temperature.

Technical Data (standard):

flow tube material:	high-grade steel 1.4541, 1.4571, Inconel, Incoloy
diameter:	DN 40 ... DN 300
length:	350 mm ... 3000 mm
pressure:	max. 100 bar
connections inlet/outlet:	flange, thread, welded connection
heating elements material:	high-grade steel 1.4541, 1.4435, 1.4828, Incoloy 2.48
heating power:	max. 100 kW , max. 12 W/cm² at the heating element
mains voltage:	max. 690 V
protection category:	IP 54, IP 65
temperature sensor:	NiCr-Ni (K), Pt 100, others
electric supply:	terminal box on the front
fastening:	screw brackets, adjustable fixing devices
protection against accidental contact:	optional detachable thermal insulation

Cartridge Heaters

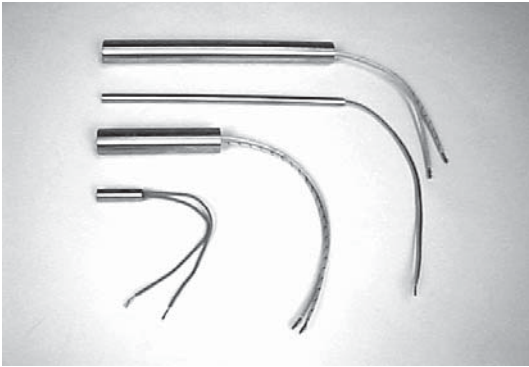

HLP

High Performance Cartridge Heaters

High performance cartridge heaters serve as heat conductors. They transfer the heat very quickly to the medium to be heated (solid bodies, liquids or gases). In contrast to conventional cartridge heaters, these cartridges have a heat-resistant casing of chromium-nickel-steel. The bottom of the cartridge heater is resistant to gas and corrosion, the surface is polished and metallically pure. The connection side has a ceramic closing.

There are no current-carrying parts outside the cartridge. For constructional reasons, there is an unheated zone at the top of the cartridge.

Technical Data

max. surface load:	50 W/cm ²
nominal temperature:	max. 750 °C
outer casing:	chromium-nickel steel
insulation material:	magnesium oxide
heating conductor:	nickel-chromium alloy NiCr 8020
connection:	silicone-impregnated glass-fiber-nickel braid
length connection line:	default: 300 mm, other lengths are available
certifications:	according to VDE 0700 part 1 / EN 60335 part 1
available accessories:	various connection lines, right-angled connections, screwed fittings, flanges, insulating plastic tubes

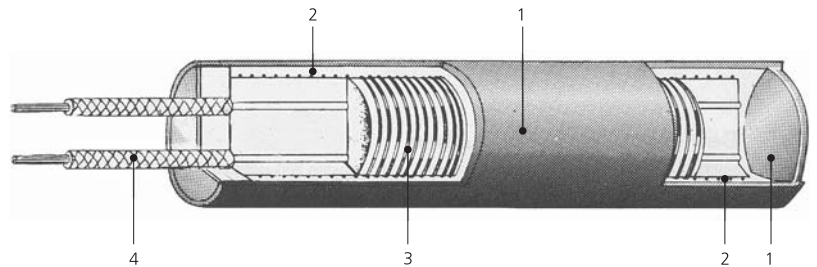

- 1 outer casing
- 2 insulating material
- 3 heating conductor
- 4 connections

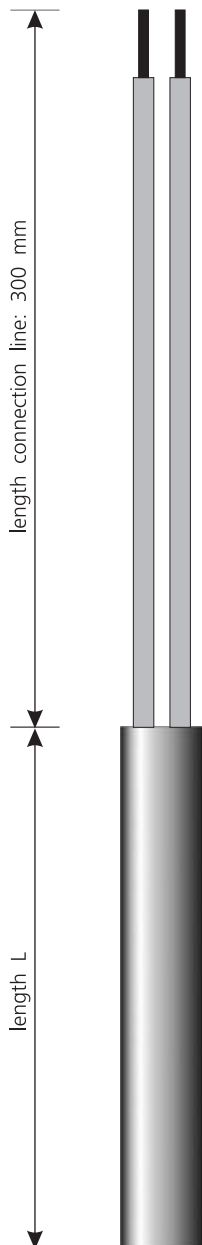

ø 6.5 mm (diameter tolerance: -0.01 ... -0.03 mm)

length L	power (watt) at 230 V								
40	100	125	160	175	200				
50	100	125	160	200	250				
60	125	160	200	250	315				
80	125	160	180	200	250	280	315	350	
100	100	160	200	250	315	350	400		
130	220	350							
160	350	400							

ø 8 mm (diameter tolerance: -0.01 ... -0.03 mm)

length L	power (watt) at 230 V								
40	100	160	200	250					
50	125	160	200	250	315				
60	100	125	140	160	200	250	280	315	
80	160	200	250	315	400	500			
100	200	250	280	315	400				
130	250	315	400						
160	200								

ø 10 mm (diameter tolerance: -0.02 ... -0.04 mm)

length L	power (watt) at 230 V									
40	100	125	200	250	315					
50	100	160	200	250	315	400				
60	125	160	200	250	315	400	500			
80	160	200	250	315	400	500	630			
100	160	200	250	315	400	500	560	630	800	
130	315	400	500	630	800					
160	400	630								
200	400	630								
250	630	800	1000							

ø 12.5 mm (diameter tolerance: -0.02 ... -0.04 mm)

length L	power (watt) at 230 V								
40	100	160	200	250	315	400			
50	100	125	160	200	250	315	400	500	
60	125	160	200	250	315	400	500		
80	200	250	315	400	500	630	800		
100	250	315	400	500	630	800	1000		
130	400	500	630	800	1000				
160	500	630	800	1000	1250				
180	800	1000							
200	630	800							
250	800	900	1500						
300	600	1500	2000						

Standard sizes (marked in grey) are in stock.

The cartridge heaters described on page 30 are available with the following additional options.

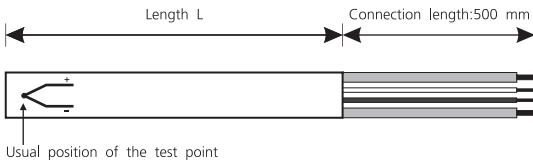

Cartridge Heater with Integrated Temperature Sensor

Alternatively, thermocouples NiCr-Ni (K), Fe-CuNi (L) or (J) as well as Pt 100 resistance thermometers can be integrated.

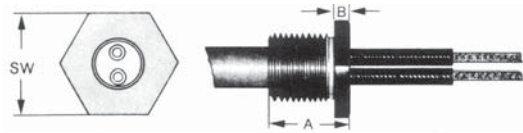

Cartridge Heater with Screw-in Stainless Steel Fitting

Welded on cartridge.

Cartridge Ø	6.5 mm	8 mm	10 mm	12.5 mm	16 mm	20 mm
A	10	10	12	12	12	14
B	4	4	4	4	4	4
SW	12	14	17	19	24	30
Thread	M 10 x 1	M 12 x 1	M 14 x 1.5	M 16 x 1.5	M 20 x 1.5	M 26 x 1.5

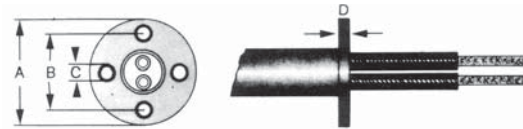

Cartridge Heater with Stainless Steel Flange (round)

Welded on cartridge.

Cartridge Ø	6.5 mm	8 mm	10 mm	12.5 mm	16 mm	20 mm
A	18	18	27	27	43	43
B	13	13	20	20	32	32
C	2.2	2.2	3.2	3.2	5.5	5.5
D	1.0	1.0	1.5	1.5	2	2

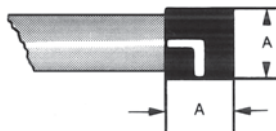

Cartridge Heater with Stainless Steel Connection Cube

Welded on cartridge.

Cartridge Ø	6.5 mm	8 mm	10 mm	12.5 mm	16 mm	20 mm
A x A	10	10	15	15	20	25



Cartridge Heater with Silicone Power Cable

Three-wire silicone-insulated cable, splash-proof

Heating Plates

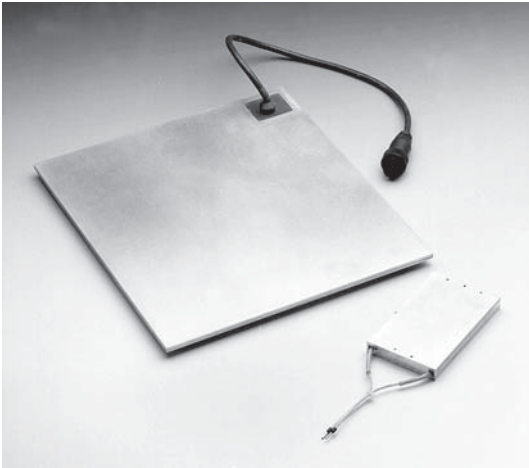

HMP

Electrical Heating Plates with Temperature Sensors and Exchangeable Heating Conductors

Electrical heating plates allow the heating of tools, containers, presses and desks. Additionally, they can be designed suitable for use in wafer production. Heating plates are also a good technical solution for heating valves, flow controllers, armatures as well as pipe systems in gas-mixing equipment.

Electrical heating plates are produced according to customers requirements. They can be designed rectangular, round or in individual outlines. Lead-throughs and fixing boreholes are considered.

Due to the good heat transfer of metal, which is used as base for the heating element, a mechanically robust design with homogenous heat distribution and high specific heater power rates is achieved.

As heating elements, electrically-insulated heating cables are applied, which are laid in grooves over the total available surface in spirals or meander-shaped with small interspaces.

The integrated heating wires are electrically insulated with silicone, PTFE, textile glass or quartz glass, depending on power requirement and nominal temperature. Due to their high flexibility, even corners and lead-throughs can be integrated. If mineral-insulated stainless steel conductors are applied, the heating plate is suitable for operation under vacuum.

The plate material is selected according to the planned application. Very suitable is aluminum, however, copper, brass and other materials can be used.

The heating surfaces can be anodized, hard-coated, coated with PTFE or surface finishes according to customers requirements. To achieve a homogenous surface temperature, several individually controllable heating circuits can be integrated.

Electrical heating plates must be temperature-controlled.

Please describe your planned application. We will offer you a suitable heating plate.

Technical Data (standard):

nominal temperature:	400 °C
length:	20 ... 2000 mm
breadth:	10 ... 1000 mm
thickness:	8 ... 25 mm
power density:	2 W/cm ²
nominal voltage:	extra-low voltages, 230 VAC 1, 230/400 V 3N
temperature sensors:	thermocouples, Pt 100

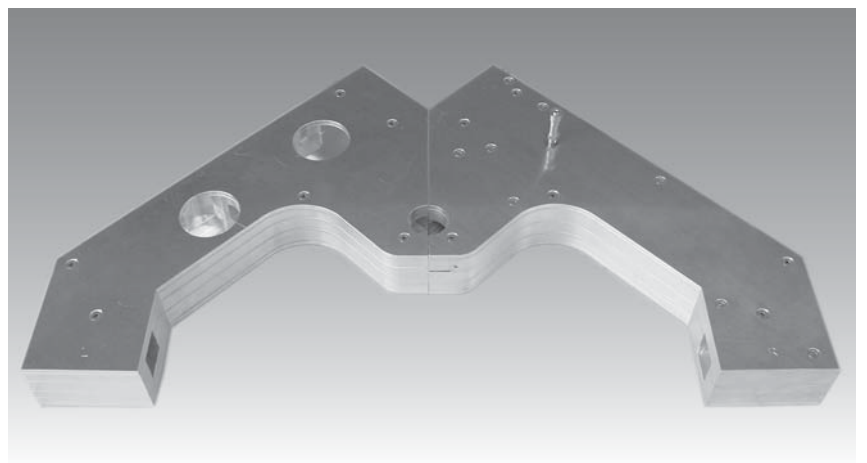
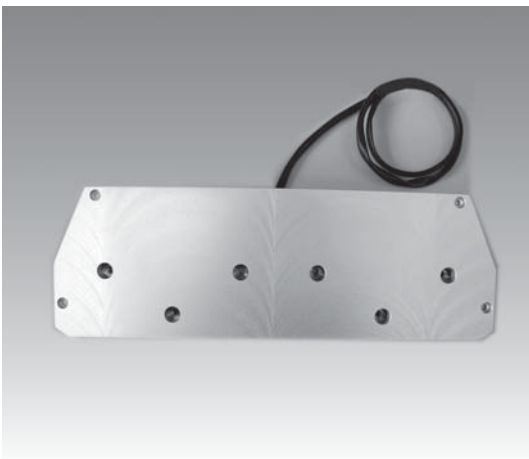
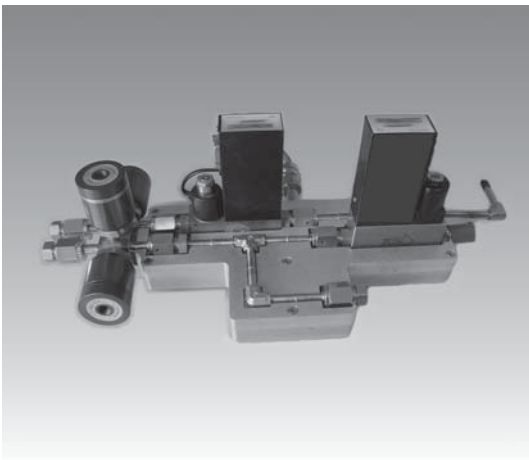

HORST Heating Hoses

Heating hoses are flexible, heated linking components. They are primarily designed to avoid temperature loss of warm media during transport. To a certain extent they can also be applied to heat-up the medium flowing through the hose. Heating hoses are produced customized using standardized components and are available from 0.3 m to 50 m. All heating hoses are individually adapted to the operation environment.

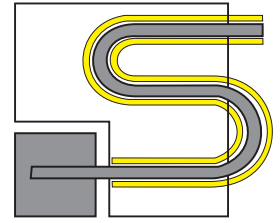

The following questions are helpful to select an appropriate model for your application:

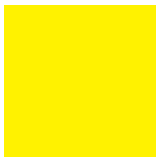

Which components should be used?

Basically, a heating hose consists of a pressure hose, connection armatures on both sides, a heating conductor and an outer mantle. To assemble the suitable components, requested nominal width, type of connection armatures and expected operating pressure have to be determined. The installed heating power and the thickness of the integrated heat insulation is calculated based on the desired operating temperature. The inner pressure hose is selected according to following criteria: For temperatures up to 250 °C medium-leading pressure hoses are made of PTFE, FEP or PFA. For temperatures higher than 250 °C, corrugated stainless steel hoses are applied. The outer mantle is designed considering criteria like flexibility, mechanical stability or humidity resistance.



Are there special requirements for the heating hose?

For exhaust measurements, heating hoses with exchangeable medium-leading inner hoses are produced. They can also be equipped with an integrated filter. Some types of heating hoses with self-limiting heating elements can be individually cut and finished on-site. Heating hoses can also be adapted to other uses, such as in the food industry or as anti-freeze water pipes.



Which temperature regulation suits the application most?

Heating hoses must be operated temperature-controlled. Therefore, all heating hoses can be equipped with one or several thermocouples or Pt 100 sensors. If overheating caused by a failing temperature regulator should be prevented, an additional overheat protection is necessary.

Please note that design and installation have to be carried out by an electrician to guarantee a safe operation of the components.

Heating Hoses

Construction of a Heating Hose - for Example Series H 13 / H 13 A

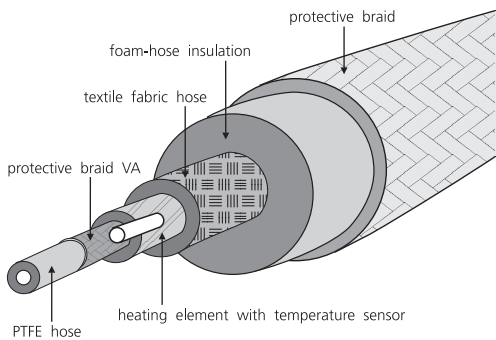

The medium-transporting PTFE inner hose is coated with a protective braid around which the heating element is mounted in narrow leads. According to VDE Norms, the heating conductor has its own protective braid. Additionally, the whole construction is humidity-resistant.

The heater capacity is adapted to the special heat requirements at different parts of the heating hose.

The temperature sensor is positioned directly on the inner hose, 300 mm from the mains supply (hoses > 10.0 m: 3000 mm). The thermal insulation consists of a multi-layer glass yarn fabric and a 10 mm hose made of synthetics or silicone foam. The polyamide braid protects the whole construction. In case of high mechanical stress, galvanized steel braids or V2A can be used. At both ends, silicone caps or polyamide hard caps are mounted.

Power Supply

A standard heating hose has the power supply at the end. Three variations are possible:

- Power supply at the side
- Power supply at the front. This is usually combined with a cable screwing, which allows to lead the hose and the power supply through the casing wall e.g. of an analytic instrument. This is the standard type of the H 13 A.
- Optional: set-back positioning, according to customers requirements.

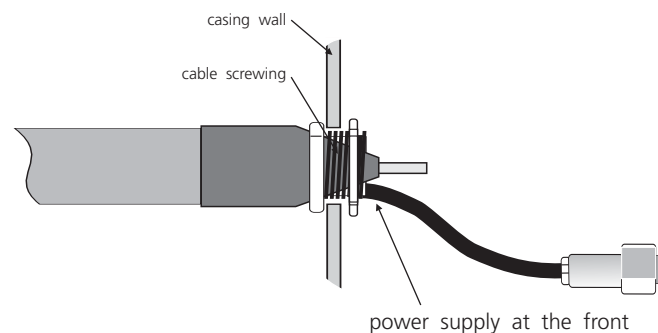
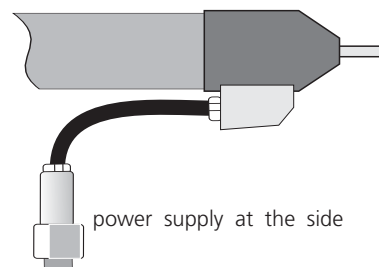

Temperature Regulation

No heating hose should be used without temperature control. Therefore all heating hoses are equipped with a Fe-CuNi thermocouple sensor. Other sensors are possible on demand.

For temperature regulation we recommend our HT MC11 regulating device (p. 48), especially in case of higher switching power rates (up to 3450 W) and for continuous operation. An economically-priced alternative is HT 20 (p. 51), which is designed for operation with heating hoses. This temperature regulator works with a robust two-pole switching mechanical relay but is not wear-free.

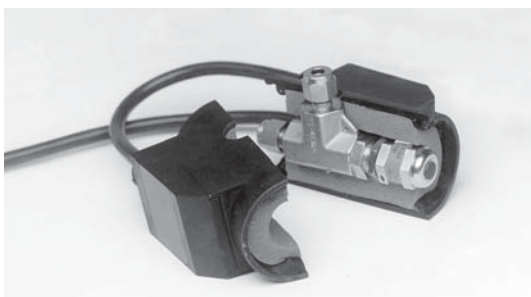
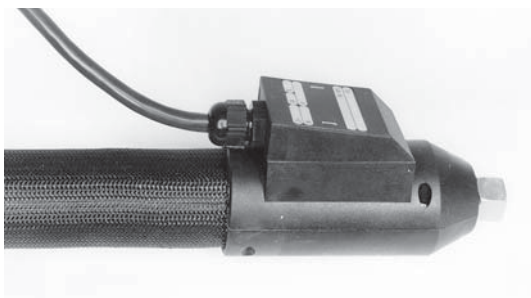
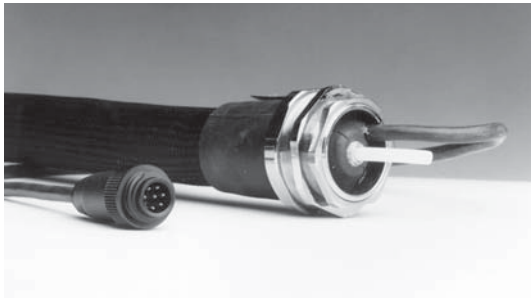
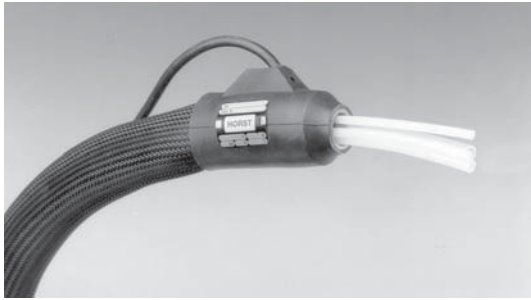

Connections

Control Cables, Plug Connections

For the operation of a current-consuming device with temperature sensor, control cables or single-wire conductors can be integrated into heating hoses and are led out at the end of the hose.

Usually, a 7-pole circular connector suitable for our temperature regulators is mounted at the power supply cable. On request other connector types are available.

Power Supply Line, Sensor Connecting Cable

The standard cable length is 1.5 m, except for the H 13 and H 13 A series, which have a mains supply line of 3 m. Other lengths are possible on request.

In addition, mains and sensor cables can be led out separately. In this case, each line needs its own plug.

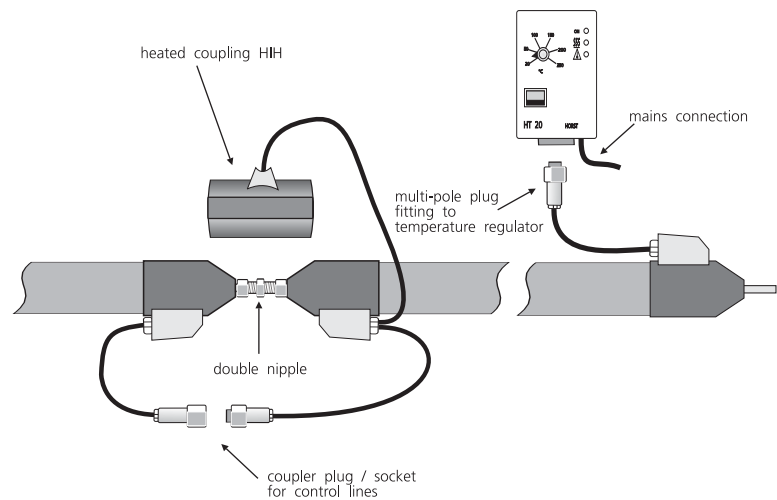

Hard End Caps Made of Polyamide 6

Connecting cables can be led out either in direction to the front or in direction to the center of the hose. All electrical connections are easily accessible, the connecting cable is strain-relieved, due to a cable gland.

The hard cap is fixed with the base hose. As a result the cap cannot be torn out or twisted by thermal expansion or strong movements. The bending point is set far behind the armature, which relieves the critical connection between hose and armature.

HIH

Heated Couplings

Heated couplings keep the temperature constant at the connecting element between two heating hoses. The inner part of the heated coupling consists of two aluminum shells, insulated with silicone foam on which the heating is fixed. The outer casing is made of PA 6 formed parts. The couplings can be opened and screwed together after installation. Inside the terminal block is a clamped connection for power supply and cable lead-through.

The power is selected to ensure a constant temperature (200 °C) in the coupling. In most cases, a regulator is not necessary but can be used. The nominal voltage is 230 V~.

On request, heated couplings can be produced with springs, which allow the heating of special branchings.

order no.	type	power	inner diameter	heated length	total length
80 10 00	HIH 08	12 W	22 mm	70 mm	96 mm
80 10 01	HIH 16	24 W	40 mm	90 mm	120 mm

Heating Hoses

Pressure Hoses

When choosing a pressure hose, please observe the minimum bending radius in order to avoid leakage.

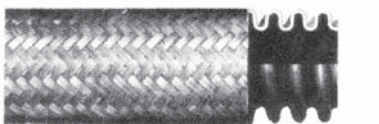
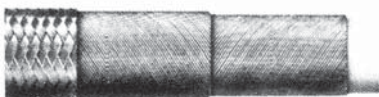
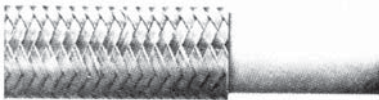

T1

Smooth PTFE hose with one braided layer of stainless steel wire (1.4301), max. operating temperature 250 °C

nominal diameter	4	6	8	10	12	16	20	25
* operating pressure [bar]	275	240	200	175	150	135	100	80
min. bending radius [mm]	50	75	100	120	135	160	200	250

* temperature correction value: 100 °C × 0.9 200 °C × 0.8 250 °C × 0.6

T2

Smooth PTFE hose with two braided layers of stainless steel wire (1.4301), max. operating temperature 250 °C

nominal diameter	6	8	10	12	16	20	25	32	40
* operating pressure [bar]	275	250	225	200	175	150	130	70	50
min. bending radius [mm]	75	100	120	135	160	200	250	500	850

* temperature correction value: 100 °C × 0.9 200 °C × 0.8 250 °C × 0.6

T3

Smooth PTFE hose with two winded and one braided layer of steel wire (1.4301), max. operating temperature 250 °C

nominal diameter	6	8	10	12	16	20	25
* operating pressure [bar]	500	475	475	450	400	300	275
min. bending radius [mm]	60	85	110	150	175	200	240

* temperature correction value: 100 °C × 0.9 200 °C × 0.8 250 °C × 0.6

T5

Corrugated stainless steel hose (1.4401 or 1.4571) with one braided layer of stainless steel wire (1.4301), max. operating temperature 550 °C

nominal diameter	4	6	8	10	12	16	20	25	32	40	50
* operating pressure [bar]	100	150	100	80	64	64	50	40	30	25	20
min. bending radius [mm]	80	80	100	150	170	190	220	250	290	480	550

* temperature correction value: 100 °C × 0.7 200 °C × 0.6 250 °C × 0.55 350 °C × 0.49 500 °C × 0.46

nominal diameter DN	inner diameter armature
4	3.0 mm
6	4.5 mm
8	6.0 mm
10	7.5 mm
12	10.0 mm
16	12.5 mm
20	16.0 mm
25	20.1 mm
32	27.5 mm
40	31.5 mm

Armatures

Our standard heating hoses have armatures made of bichromate machining steel. We also offer armatures made of stainless steel (1.4301 / 1.4571) or brass. The durability of the heating hose and armature should correspond. On request, the heating hoses can be equipped with loose flanges or integral flanges, according to DIN and ASA.

Please consider that armatures narrow the passage of the hose! See table on left.

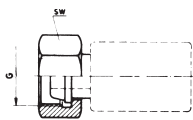

DKR DIN 3863
Universal conical nipple,
union nut inch (BSP)

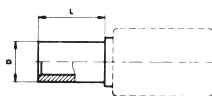

RSL/RSS
pipe connection,
light/heavy duty series
for clamp ring connection

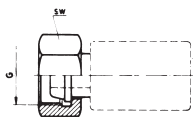

DKL/DKM/DKS
DIN 3863
Universal conical nipple,
union nut metric thread,
light/heavy duty series

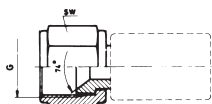

DKJ
Nipple with 74° conus JIC,
union nut UNF thread

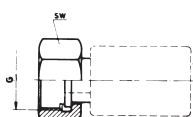

BDN
Flanged nut, flat packing,
union nut metric/inch

nominal diameter DN	inch thread	inch thread
4	G 1/8" - 28	G 1/4" - 19
6	G 1/4" - 19	
8	G 3/8" - 19	
10	G 3/8" - 19	G 1/2" - 14
12	G 1/2" - 14	G 5/8" - 14

nominal diameter DN	inch thread	inch thread
16	G 3/4" - 14	
20	G 1" - 11	
25	G 1" - 11	G 1 1/4" - 11
32	G 1 1/4" - 11	G 1 1/2" - 11
40	G 1 1/2" - 11	

nominal diam. DN	outer diameter of tube light	outer diameter of tube heavy
4	6	8
6	8	10
8	10	12
10	12	14
12	15	16

nominal diam. DN	outer diameter of tube light	outer diameter of tube heavy
16	18	20
20	22	25
25	28	30
32	35	38
40	42	

nominal diameter DN	DKL	DKM	DKS
4	12 × 1.5		
6	14 × 1.5		18 × 1.5
8	16 × 1.5		20 × 1.5
10	18 × 1.5		22 × 1.5
12	22 × 1.5		24 × 1.5

nominal diameter DN	DKL	DKM	DKS
16	26 × 1.5		30 × 2
20	30 × 2	30 × 1.5	36 × 2
25	36 × 2	38 × 1.5	42 × 2
32	45 × 2	45 × 1.5	52 × 2
40	52 × 2	52 × 1.5	

nominal diameter DN	inch thread	metric thread
4	7/16"	20 UNF
6	1/2"	20 UNF
8	1/2"	20 UNF
8	9/16"	18 UNF
8	5/8"	18 UNF
10	9/16"	18 UNF
10	3/4"	16 UNF

nominal diameter DN	inch thread	metric thread
12	3/4"	16 UNF
16	7/8"	14 UNF
20	1 1/16"	12 UNF
25	1 5/16"	12 UNF
32	1 5/8"	12 UNF
40	1 7/8"	12 UNF

nominal diam. DN	inch thread	metric thread
4	R 1/4"	14 × 1.5
8	R 3/8"	16 × 1.5
10	R 3/8"	18 × 1.5
10	R 1/2"	
12	R 1/2"	22 × 1.5

nominal diam. DN	inch thread	metric thread
16	R 3/4"	26 × 1.5
20	R 1"	30 × 2
25	R 1 1/4"	36 × 2
32	R 1 3/4"	52 × 2
40	R 1 1/2"	

order no.	option: armatures V2A on both sides
89 20 25	nominal diameter DN 04 - 10
89 20 26	nominal diameter DN 12 - 16
89 20 27	nominal diameter DN 20

order no.	option: armatures V4A on both sides
89 20 28	nominal diameter DN 04 - 10
89 20 29	nominal diameter DN 12 - 16
89 20 30	nominal diameter DN 20

Outer Protective Hoses

Approximate outer diameter values of heating hoses with polyamide protective braid, using the example of heating hoses series H 12:

nominal diameter DN	04	06	08	10	12	16	20	25	32	40	50
outer Ø mm ± 10 %:	40	40	40	45	45	50	50	55	60	70	85

If other outer protective hoses or a different heating hose series is used, the outer diameter might increase by up to 10 mm.



Polyamide Protective Braid

Material: PA 6, polyamide. Heat-resistant up to 150 °C, very flexible and light, usually black - but also available in other colors.

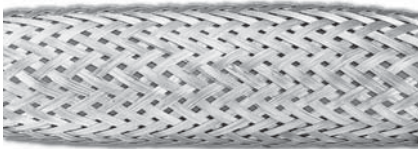

Metal Protective Braid

Material: steel, galvanized or V2A. Heat-resistant from 300 °C to 500 °C, very flexible and light, very good protection against abrasion.

order no.	<u>option: metal protective braid, V2A</u>	order no.	<u>option: metal protective braid, steel, galvanized</u>
89 20 10	nominal diameter DN 04 - 10	89 20 13	nominal diameter DN 04 - 10
89 20 11	nominal diameter DN 12 - 16	89 20 14	nominal diameter DN 12 - 16
89 20 12	nominal diameter DN 20 - 25	89 20 15	nominal diameter DN 20 - 25

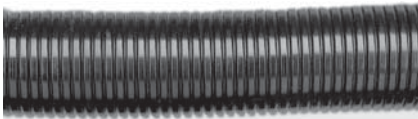

Plastic Corrugated Hose

Material: PA 6, polyamide. Heat-resistant up to 120 °C, very flexible, hard-wearing, flame retardant, halogen-free.

order no.	<u>option: plastic corrugated hose, PA 6</u>
89 20 16	nominal diameter DN 04 - 10
89 20 17	nominal diameter DN 12 - 16
89 20 18	nominal diameter DN 20 - 25



PU Corrugated Hose with Steel Spiral

Material: PU, polyurethane. Heat-resistant up to 90 °C, very flexible, suitable for applications on robots, hard-wearing, flame retardant, halogen-free.

order no.	<u>option: PU corrugated hose</u>
89 20 60	nominal diameter DN 04 - 10
89 20 64	nominal diameter DN 12 - 16
89 20 68	nominal diameter DN 20 - 25



Metal Corrugated Hose

Material: galvanized steel. Heat-resistant up to 300 °C, very flexible, hard-wearing, resistant against sharp objects and chippings.

order no.	<u>option: metal corrugated hose</u>
89 20 19	nominal diameter DN 04 - 10
89 20 20	nominal diameter DN 12 - 16
89 20 21	nominal diameter DN 20 - 25

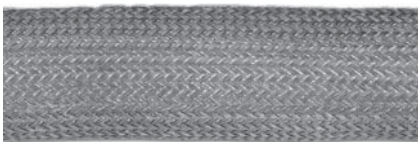

Glass Fabric Protective Hose

Material: glass fiber, black. Temperature stability up to 400 °C, very flexible with very good protection against abrasion. Protection against glowing chippings.

order no.	<u>option: glass fabric protective hose</u>
89 20 22	nominal diameter DN 04 - 10
89 20 23	nominal diameter DN 12 - 16
89 20 24	nominal diameter DN 20 - 25

Optional Equipment

order no.	
89 20 01	Pt 100 sensor instead of Fe-CuNi
89 20 02	thermal switch (opener), limit values: 80 °C, 100 °C, 180 °C, 200 °C
89 20 03	control cable per conductor and meter heating hose 0.75 Ø
89 20 00	control cable per conductor and meter heating hose 1.5 Ø
89 20 04	extended control cable per meter 3-conductor
89 20 05	extended control cable per meter 5-conductor
89 20 06	extended control cable per meter 7-conductor
89 20 07	7-pole coupling "Binder S693", mounting for control cable included
89 20 08	extended power supply per meter
89 20 09	mains / sensor separated with 7-pole diode plug

Heating Hoses



Heating Hose Series H 12

Heating Hose with many Variants

The modular design and a wide range of options allow the H 12 heating hoses to be adapted to various operating conditions. Nominal temperature, pressure resistance, length, number and position of temperature sensors, outer protective hoses according to the demands on mechanical stress and much more can be combined.

This series is commonly used in research and industry and is suitable for viscous media like oil, grease, wax, resin, but can also be used for plastics as well as for water and other liquids.

Technical Data Basic Configuration

pressure hose: T1, T2, T3 or T5 (description see page 36)
 nominal diameter (DN): 4 ... 50 (larger sizes on request)
 nominal voltage: 230 V~
 temperature sensor: Fe-CuNi (J)
 armatures: see list on page 36
 connection: 1.5 m, 5-conductor silicone cable with sensor line and multi-pole plug (suitable for HT 20 regulators on page 51 and HT MC 11 on page 48)
 outer protective hose: polyamide, black (extra charge for others, see page 37)

Ordering instructions:

The price for a heating hose is calculated as follows:
 total price = basic price + (length × price per meter)
 For order numbers see list on the right.

Pressure hoses T1, T2, T3 and T5 see page 36.

Heating hoses with T5 pressure hose need armatures made of stainless steel. The order number for this option is listed on page 36.

Outer protective hoses and further optional equipment on page 37.

Sample Configuration 1:

6 m H12 heating hose, max. temp. 200 °C, T2 pressure hose, nominal diameter: 16 mm, outer protective hose: metal corrugated hose

order no.	quantity	
89 15 86	1	basic price H12 - 200 °C, DN 16, T2
89 16 06	6	price per meter H12 - 200 °C, DN 16, T2
89 20 20	6	surcharge: metal corrugated hose DN 12-16

Sample Configuration 2:

5 m H12 heating hose, max. temp. 250 °C, T5 pressure hose, nominal diameter: 10 mm, outer protective hose: metal protective braid

order n..	quantity	
89 17 44	1	basic price H12 - 250 °C, DN 10, T5
89 17 64	5	price per meter H12 - 250 °C, NW 10, T5
89 20 25	1	surcharge for pressure hose T5: armatures V2A, DN 04-10
89 20 10	5	surcharge: metal protective braid DN 04-10

H 12 - max. 100 °C

DN	W/m	pressure hose T1 order numbers		pressure hose T2 order numbers		pressure hose T3 order numbers		pressure hose T5 order numbers	
		basic price	price per m	basic price	price per m	basic price	price per m	basic price	price per m
4	80	89 13 81	89 14 01						
6	100	89 13 82	89 14 02	89 14 22	89 14 42			89 15 02	89 15 22
8	120	89 13 83	89 14 03	89 14 23	89 14 43	89 14 63	89 14 83	89 15 03	89 15 23
10	140	89 13 84	89 14 04	89 14 24	89 14 44	89 14 64	89 14 84	89 15 04	89 15 24
12	160	89 13 85	89 14 05	89 14 25	89 14 45	89 14 65	89 14 85	89 15 05	89 15 25
16	200	89 13 86	89 14 06	89 14 26	89 14 46	89 14 66	89 14 86	89 15 06	89 15 26
20	260	89 13 87	89 14 07	89 14 27	89 14 47	89 14 67	89 14 87	89 15 07	89 15 27
25	330	89 13 88	89 14 08	89 14 28	89 14 48	89 14 68	89 14 88	89 15 08	89 15 28
32	380			89 14 29	89 14 49			89 15 09	89 15 29
40	440			89 14 30	89 14 50			89 15 10	89 15 30
50	550			89 14 31	89 14 51			89 15 11	89 15 31

H 12 - max. 200 °C

DN	W/m	pressure hose T1 order numbers		pressure hose T2 order numbers		pressure hose T3 order numbers		pressure hose T5 order numbers	
		basic price	price per m	basic price	price per m	basic price	price per m	basic price	price per m
4	100	89 15 41	89 15 61						
6	120	89 15 42	89 15 62	89 15 82	89 16 02		89 16 62	89 16 82	
8	140	89 15 43	89 15 63	89 15 83	89 16 03	89 16 23	89 16 43	89 16 63	89 16 83
10	160	89 15 44	89 15 64	89 15 84	89 16 04	89 16 24	89 16 44	89 16 64	89 16 84
12	200	89 15 45	89 15 65	89 15 85	89 16 05	89 16 25	89 16 45	89 16 65	89 16 85
16	260	89 15 46	89 15 66	89 15 86	89 16 06	89 16 26	89 16 46	89 16 66	89 16 86
20	330	89 15 47	89 15 67	89 15 87	89 16 07	89 16 27	89 16 47	89 16 67	89 16 87
25	370	89 15 48	89 15 68	89 15 88	89 16 08	89 16 28	89 16 48	89 16 68	89 16 88
32	440			89 15 89	89 16 09			89 16 69	89 16 89
40	550			89 15 90	89 16 10			89 16 70	89 16 90
50	660							89 16 71	89 16 91

H 12 - max. 250 °C

DN	W/m	pressure hose T1 order numbers		pressure hose T2 order numbers		pressure hose T3 order numbers		pressure hose T5 order numbers	
		basic price	price per m	basic price	price per m	basic price	price per m	basic price	price per m
4									
6	120			89 17 02	89 17 22			89 17 42	89 17 62
8	140			89 17 03	89 17 23	89 18 21	89 18 31	89 17 43	89 17 63
10	160			89 17 04	89 17 24	89 18 22	89 18 32	89 17 44	89 17 64
12	200			89 17 05	89 17 25	89 18 23	89 18 33	89 17 45	89 17 65
16	260			89 17 06	89 17 26	89 18 24	89 18 34	89 17 46	89 17 66
20	330			89 17 07	89 17 27	89 18 25	89 18 35	89 17 47	89 17 67
25	370			89 17 08	89 17 28	89 18 26	89 18 36	89 17 48	89 17 68
32	440			89 17 09	89 17 29			89 17 49	89 17 69
40	550			89 17 10	89 17 30			89 17 50	89 17 70
50	660			89 17 11	89 17 31			89 17 51	89 17 71

H 12 - max. 350 °C

DN	W/m	pressure hose T1 order numbers		pressure hose T2 order numbers		pressure hose T3 order numbers		pressure hose T5 order numbers	
		basic price	price per m	basic price	price per m	basic price	price per m	basic price	price per m
4									
6	190							89 17 82	89 18 02
8	220							89 17 83	89 18 03
10	250							89 17 84	89 18 04
12	280							89 17 85	89 18 05
16	310							89 17 86	89 18 06
20	400							89 17 87	89 18 07
25	460							89 17 88	89 18 08
32	610							89 17 89	89 18 09
40	660							89 17 90	89 18 10
50	880							89 17 91	89 18 11

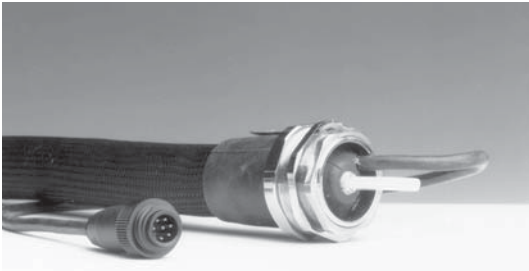
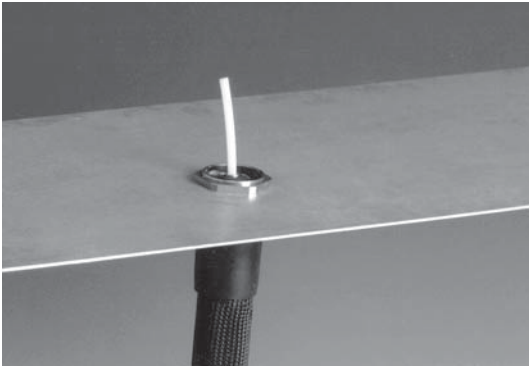

Series H 13 A

Heated Sampling Hose with Exchangeable PTFE Inner Tube

The PTFE inner tube of this heated sampling hose runs without being interrupted by metal screwings from the gas take-off point to the analyzer. In case of deposits, it can easily be exchanged.

The inside of the heated carrier hose, through which the inner tube is led, consists of a continuous metal corrugated hose. This metal hose offers very good heat conduction, homogenous heat distribution to the entire length, light weight and high flexibility.

Cable screwings at both ends allow easy mounting. With these cable screwings the heating hose can be vertically fixed on a chimney (please consider strain-relief) or on the side wall of an analytic instrument.

The maximum operating temperature of PTFE is 250 °C. For higher temperatures, tubes made of VA, titanium or similar materials are required.

Technical Data Basic Configuration

max. length:	50 m	fixing:	screwings
nominal diameter (DN):	4 ... 20	borehole:	Ø 47 mm
nominal voltage:	230 V~		
temperature sensor:	Fe-CuNi (J)		
connection:	silicone hose line (3 m) with integrated sensor line and multi-pole plug (e.g. for HT 20 temperature regulator (p. 51) and HT MC11 (p. 48))		
outer protective hose:	polyamide, black		
optional equipment:	see page 37		

Ordering Instructions:

The price for a heating hose is calculated as follows:
 total price = basic price + (length × price per meter)
 For order numbers see list on the right.

Outer protective hoses and further optional equipment on page 37.

Sample Configuration:

6 m H13 A heating hose, max. temp. 200 °C, nominal diameter: 16 mm, outer protective hose: metal corrugated hose.

order no.	quantity	
89 11 46	1	basic price H13 A - 200 °C, DN 16
89 11 66	6	price per meter H13 A - 200 °C, DN 16
89 20 20	6	surcharge: metal corrugated hose DN 12-16

H 13 A - max. 100 °C

with PTFE inner tube		order numbers	
DN	W/m	basic price	price per m
4	100	89 11 01	89 11 21
6	120	89 11 02	89 11 22
8	140	89 11 03	89 11 23
10	160	89 11 04	89 11 24
12	200	89 11 05	89 11 25
16	260	89 11 06	89 11 26
20	330	89 11 07	89 11 27

H 13 A - max. 200 °C

with PTFE inner tube		order numbers	
DN	W/m	basic price	price per m
4	120	89 11 41	89 11 61
6	140	89 11 42	89 11 62
8	160	89 11 43	89 11 63
10	200	89 11 44	89 11 64
12	260	89 11 45	89 11 65
16	330	89 11 46	89 11 66
20	380	89 11 47	89 11 67

H 13 A - max. 250 °C

with PTFE inner tube		order numbers	
DN	W/m	basic price	price per m
4	120	89 11 81	89 12 01
6	140	89 11 82	89 12 02
8	160	89 11 83	89 12 03
10	200	89 11 84	89 12 04
12	260	89 11 85	89 12 05
16	330	89 11 86	89 12 06
20	380	89 11 87	89 12 07

H 13 A - max. 350 °C

with VA inner tube		order numbers	
DN	W/m	basic price	price per m
4	170	89 12 21	89 12 41
6	200	89 12 22	89 12 42
8	220	89 12 23	89 12 43

*operating pressure / bar min. bending radius / mm

inner hose			inner hose		
DN	PTFE	VA	DN	PTFE	VA
4	18	60	4	200	300
6	13	60	6	250	350
8	10	50	8	300	400
10	8	50	10	350	500
12	6	40	12	400	600

* temperature correction value: 100 °C × 0.9 200 °C × 0.8 250 °C × 0.7

Replacement Inner Tubes

DN	order no.	price per meter
	PTFE	VA
4	80 00 10	80 00 20
6	80 00 11	80 00 21
8	80 00 12	
10	80 00 13	
12	80 00 14	
16	80 00 15	

Analysis Heating Hose with Integrated Filter

Analysis heating hoses with integrated filters are a combination of two previously separate systems: heated hoses and heated filter elements. They are designed for applications with portable measuring instruments. The design focuses on optimal flexibility and light weight.

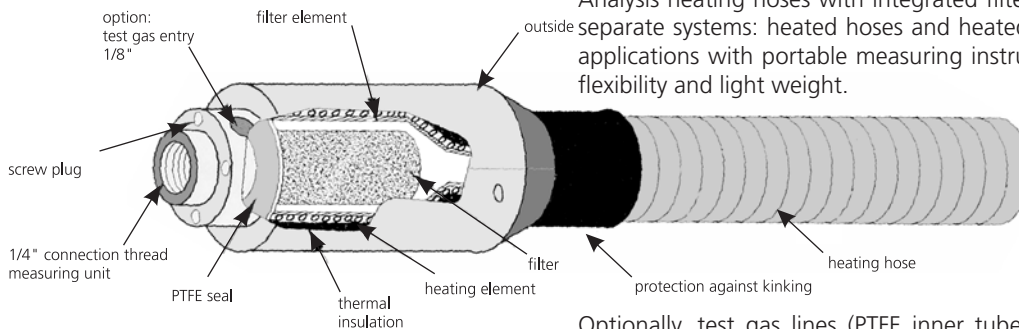

Optionally, test gas lines (PTFE inner tube with 2/3 mm or 4/6 mm inner/outer diameter) and control lines can be incorporated. The filter housing is made of V4A (1.4571) steel, but can also be produced with Hasteloy or PTFE coating. The heating hoses can easily be connected to several HORST temperature regulators.

The filter housing can be adapted to different filter dimensions, hose diameters and hose lengths. This series is adaptable to our complete range of analysis hoses and is therefore suitable for various analysis applications.

Heating Hoses



Ordering Instructions:

The price for a heating hose is calculated as follows:
total price = basic price + (length × price per meter)
For order numbers see list on the right.

Outer protective hoses and further optional equipment on page 37.

Sample Configuration:

6 m H13 heating hose, max. temp. 200 °C, nominal diameter: 12 mm, outer protective hose: metal corrugated hose

order no..	quantity	
89 13 05	1	basic price H13 - 200 °C, DN 12
89 13 25	6	price per meter H13 - 200 °C, DN 12
89 20 20	6	surcharge: metal corrugated hose DN 12-16

Series H 13

Heated Sampling Hose

These flexible sampling hoses have an irremovable PTFE inner tube and a pipe socket made of V4A stainless steel (1.4571) for fixing cutting-ring screwings.

Technical Data Basic Configuration

nominal diameter: 4 ... 12, larger on request
nominal voltage: 230 V~
temperature sensor: Fe-CuNi (J)
armatures: RSL V4A (1.4571) pipe connection
connection: silicone cable (3 m) with integrated sensor line and multi-pole plug (e.g. for HT 20 temperature regulator (p. 51) and HT MC11 (p. 48))
outer protective hose: polyamide, black

	DN 4	DN 6	DN 8	DN 10	DN 12
* operating pressure:	20 bar	20 bar	20 bar	15 bar	15 bar
min. bending radius:	50 mm	75 mm	100 mm	120 mm	130 mm

* temperature correction value: 100 °C × 0.9 200 °C × 0.8 250 °C × 0.7

H 13 - max. 100 °C

DN	W/m	order numbers	
		basic price	price per m
4	80	89 12 61	89 12 81
6	100	89 12 62	89 12 82
8	120	89 12 63	89 12 83
10	140	89 12 64	89 12 84
12	160	89 12 65	89 12 85

H 13 - max. 200 °C

DN	W/m	order numbers	
		basic price	price per m
4	100	89 13 01	89 13 21
6	120	89 13 02	89 13 22
8	140	89 13 03	89 13 23
10	160	89 13 04	89 13 24
12	200	89 13 05	89 13 25

H 13 - max. 250 °C

DN	W/m	order numbers	
		basic price	price per m
4	100	89 13 41	89 13 61
6	120	89 13 42	89 13 62
8	140	89 13 43	89 13 63
10	160	89 13 44	89 13 64
12	200	89 13 45	89 13 65

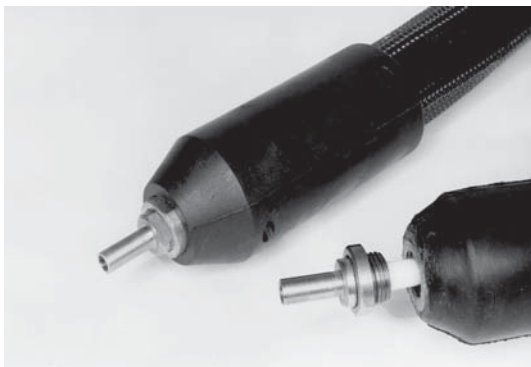

Ordering Instructions:

The price for a heating hose is calculated as follows:
total price = basic price + (length × price per meter)
For order numbers see list on the right.

Outer protective hoses and further optional equipment on page 37.

Sample Configuration:

6 m H13 C heating hose, max. temp. 200 °C, nominal diameter: 6 mm, outer protective hose: metal corrugated hose

order no..	quantity	
89 18 92	1	basic price H13 C - 200 °C, DN 6
89 19 02	6	price per meter H13 C - 200 °C, DN 6
89 20 19	6	surcharge: metal corrugated hose DN 04-10

Series H 13 C

Exchangeable PTFE Inner Tube and V4A RSL Special Armature

The pipe ends of this heating hose are equipped with a special armature made of V4A steel (1.4571), on which a cutting-ring screwing can be applied. This avoids breaking or moving of the PTFE inner tube at the ends of the heating hose. H 13 C heating hoses are also available with cable screwings on one or both ends.

Technical Data Basic Configuration

max. length: 50 m
nominal diameter: 4 ... 8
nominal voltage: 230 V~
connection: silicone cable (3 m) with integrated sensor line and multi-pole plug (e.g. for HT 20 temperature regulator (p. 51) and HT MC11 (p. 48))
outer protective hose: polyamide, black, optional equipment on page 37

	DN 4	DN 6	DN 8	DN 10	DN 12
* operating pressure:	18 bar	13 bar	10 bar	8 bar	6 bar
min. bending radius:	200 mm	250 mm	300 mm	350 mm	400 mm

* temperature correction value: 100 °C × 0.9 200 °C × 0.8 250 °C × 0.7

H 13 C - max. 100 °C

DN	W/m	order numbers	
		basic price	price per m
4	100	89 18 71	89 18 81
6	120	89 18 72	89 18 82
8	140	89 18 73	89 18 83

H 13 C - max. 200 °C

DN	W/m	order numbers	
		basic price	price per m
4	120	89 18 91	89 19 01
6	140	89 18 92	89 19 02
8	160	89 18 93	89 19 03

H 13 C - max. 250 °C

DN	W/m	order numbers	
		basic price	price per m
4	120	89 19 11	89 19 21
6	140	89 19 12	89 19 22
8	160	89 19 13	89 19 23

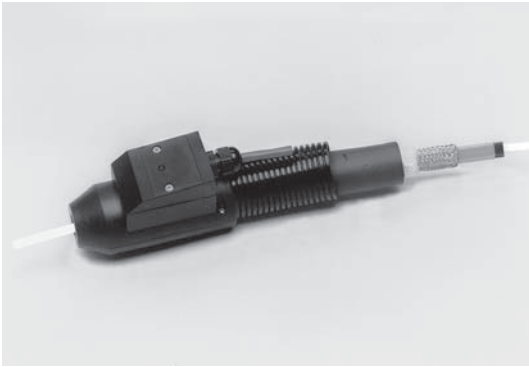

option: finishing set series H 13 B

Ordering Instructions:

The price for an H 13 B heating hose is calculated by the product of length x price per meter plus price for factory-made finish or finishing set for the self-mounting. For order numbers see list on the right.

Further optional equipment see page 37.

Sample Configuration:

6 m H13 B heating hose, temp. 120 °C, nominal diameter: 12 mm, with factory-made finish

order no..	quantity	
89 18 55	6	price per meter H13 B - 120 °C, DN 12
89 18 63	1	factory-made finish DN 12 - 16

Series H 13 B

Self-Limiting Heating Hose with Irremovable PTFE Inner Tube

Self-limiting heating hoses continuously adapt their heating power depending on media and ambient temperatures: the heating power increases when the temperature falls, it decreases when the temperature rises. If temperature differences occur in some sections of the heating hose, the heating power is adapted section by section to the ambient temperature. The result is a homogenous heating-up.

Self-limiting heating hoses are designed for heat loss compensation of tempered media. The temperature specifications of H 13 B heating hoses refer to the maximum admissible medium temperature and its maintenance at 10 °C ambient temperature.

Ready-made heating hoses can optionally be equipped with thermocouples or Pt 100 temperature sensors.

Up to a length of 100 m, H 13 B heating hoses are also available by the meter for self-finishing. The length of the heating hose can be determined on the spot (max. length 80 m / 60 m), afterwards it will be mechanically and electrically finished with optional finishing sets.

Technical Data Basic Configuration

nominal voltage: 230 V~, other nominal voltages on request
 armatures: without, PTFE tube protruding
 end caps: with strain-relief and bend protection in PA 6
 outer protective hose: polyamide 6 corrugated hose, flame-retardant, halogen-free
 outer diameter: 42 mm +/- 10 %
 protection category: IP 44 (EN 60529)
 safety class: I

H 13 B - 60 °C Maintain Temperature

Additional Technical Data:

heating power: 31 W/m at 10 °C
 * pressure correction: 100 °C x 0.9 200 °C x 0.8
 max. length: 80 m

NW	order no. price per m	min. bending radius	* operating pressure
4	89 18 41	200 mm	18 bar
6	89 18 42	250 mm	13 bar
8	89 18 43	300 mm	10 bar
10	89 18 44	350 mm	8 bar
12	89 18 45	400 mm	6 bar

H 13 B - 100 °C Maintain Temperature

Additional Technical Data:

heating power: 40 W/m at 10 °C
 * pressure correction: 100 °C x 0.9 200 °C x 0.8
 max. length: 60 m

NW	order no. price per m	min. bending radius	* operating pressure
4	89 18 51	200 mm	18 bar
6	89 18 52	250 mm	13 bar
8	89 18 53	300 mm	10 bar
10	89 18 54	350 mm	8 bar
12	89 18 55	400 mm	6 bar

H 13 B - Finishes

order no.	
89 18 61	factory-made finish nominal diameter DN 4 - 6
89 18 62	factory-made finish nominal diameter DN 8 - 10
89 18 63	factory-made finish nominal diameter DN 12 - 16
89 18 65	finishing set for self-mounting

Heating Hoses



H 14 - 40 °C / 80 °C

Vulcanized Industrial Hose, Heated

Design

Single layers of NBR hoses (hoses made of nitrile butadiene rubber) are vulcanized during production. The result is a flexible hose with smooth inner surface and great mechanical stability.

Heating

The heating element and a Pt 100 temperature sensor are integral parts of the vulcanized hose structure.

The embedded heating element and its proximity to the medium guarantees a good heat transfer. On the outside heat-insulating materials are used, which limit the handiness only insignificantly. With this design, the armatures are included in the heating.

Materials

The hoses are suitable for water, oil, fat, as well as for alcoholic and other substances compatible with NBR. Materials in contact with the medium are chosen accordingly. The outer mantle is mechanically robust and selected in view of good abrasion resistance. Short-term cleaning with steam up to 130 °C is possible.

For use as suction hoses, reinforced versions with integrated steel spirals are optionally available.

Armatures

Dead-zone free screw pipe connections according to DIN 11851 (RD) made of stainless steel 1.4301, as well as other common or customized armatures e.g. quick couplings, conical couplings, screwing nuts, thread sockets and flanges can be fitted.

Application

On request medium-leading hose components according to EG 1935/2004, as well as corresponding to the recommendations XXI cat. 2 of the BfR and CFR § 177.2600 of the FDA, suitable for transport of foodstuffs, can be offered.

The heating hoses must be temperature-controlled. In our range of products we have devices suitable for many different applications.

Technical Data Basic Configuration

operating temperature: 40 °C or 80 °C
 nominal voltage: 230 V~, others up to 500 V
 protection category: up to IP 44
 safety class: I
 length: max. 40 m

DN	W/m		screw pipe connection acc. DIN 11851 (RD)	wall thickness	operating pressure	min. bending radius
	H 14 - 40 °C	H 14 - 80 °C				
20	30	50	44 × 1/6"	6 mm	10 bar	150 mm
25	40	60	52 × 1/6"	6 mm	10 bar	175 mm
32	50	75	58 × 1/6"	6 mm	10 bar	225 mm
40	60	90	65 × 1/6"	7 mm	10 bar	280 mm
50	75	120	78 × 1/6"	7 mm	10 bar	350 mm
65	90	150	95 × 1/6"	7 mm	10 bar	455 mm
80	110	220	110 × 1/4"	8 mm	10 bar	560 mm
100	140	250	130 × 1/4"	8 mm	10 bar	700 mm

HORST Temperature Regulators

Most electrical heatings have to be temperature-controlled. In our experience as a producer of electrical heatings, we know the requirements of temperature regulating devices. Our products combine control quality, quick start-up times and reasonable prices.

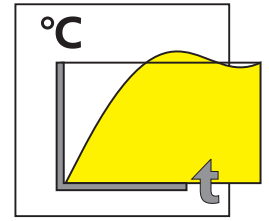

Following questions help to select an appropriate model for your application:

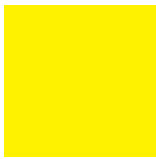

Which requirements should the housing fulfill?

Desktop models are equipped with pluggable connections and can be used for different combinations of devices. For stationary use, wall mounting is suitable – in this case the regulator is permanently connected to a heater. Several devices are suitable for integration into switching cabinets with top hat rail mounting. Splash-proof models are appropriate for outdoor use.



Which control characteristics are required?

The required control characteristics apply to the demand for accuracy and temperature stability. A basic and budget-priced P characteristic is often enough. If a temperature overshoot should be avoided, a regulator with PD characteristics is selected. PID characteristics with self-optimization of regulating parameters meet high demands for accuracy and stability.



Which kind of power control is required?

Suitable for electric supply network and current consumption, we offer one-phase regulators for alternating current or three-phase regulators for rotary current. In case of low demands on switching frequencies and accuracy, reasonably-priced mechanical relays or contactors can be used. More expensive power controllers work wear-free with semiconductor relays and high switching frequencies.

Please consider following consumer connection options: e.g. limit contacts, signal contacts, limit comparators (for the temperature-dependent switching of separate circuits), ramp functions or program functions. If a failing regulator could lead to a fire hazard or if the connected heater could cause damage to the heated component or its medium, an independent overheating protection must be installed.

Please contact us if you need any assistance.

Temperature Regulators



HT 30

Versatile Temperature Regulator with Electronic Outlet for up to 10 A

If a controlled and careful heating-up is required, the combination of power controller and PD temperature regulator produces reliable results.

With this electronic power controller the nominal power can be adjusted between 100 % to 0 according to individual power requirements. This is especially important at low temperatures when too much power would cause an overswing of the control circuit.

The set-point of the temperature regulator can be digitally adjusted into increments of 1 °C. Due to the adjustable control amplifier, the regulator can be adapted to the respective controlled system. The accuracy can be kept even if there are extreme demands on differing control systems.

If the sensor connection or the sensor element is broken, the device shuts down immediately. A control lamp indicates the failure.

With an apparatus clamp, the regulator can be easily mounted onto a stand. The clamp can be fixed on the rear of the device.

Linear voltage output:

For the connection e.g. to a recording instrument or a digital display, the regulator has a linearized voltage output.

Technical Data

two-position regulator			
control system:	P-PD	power control:	0 ... 100 %
power control:	triac	safety class:	I
switching power:	2300 W at 230 V	protection category:	IP 30 (EN 60529)
main switch:	2-pole, illuminated	mains cable:	1.5 m
degree of accuracy:	1 %	case dimensions:	75 × 115 × 145 mm
servo amplifier:	0.5 ... 5 %	case material:	coated steel/aluminum
actual value output:	10 mV		

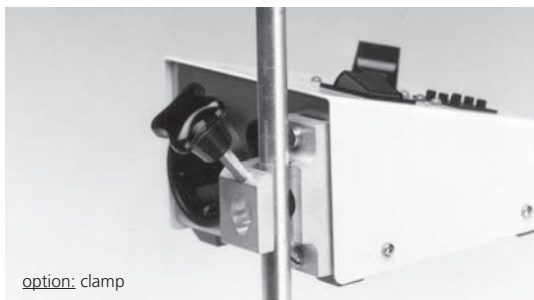
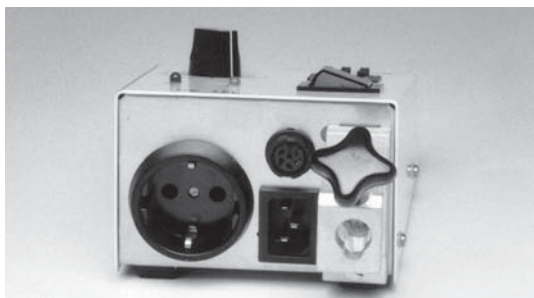

option: clamp

order no.	switching power	sensor type	order no.	accessory
06 30 01	10 A	NiCr-Ni (K)	08 07 02	clamp
06 30 02	10 A	Pt 100	07 99 01	plug for the connection to temp. sensor
			07 99 03	plug for analog output

Temperature sensors see page 57.



HT 31

Versatile Temperature Regulator with Electronic Outlet for up to 15 A

The HT 31 regulator has the technical features of the HT 30, but additionally allows switching power rates up to 15 A.

Technical Data

Differences to HT 30:		switching power:	3450 W at 230 V
		mains cable:	1.3 m
		case dimensions:	74 × 161 × 136 mm

order no.	switching power	sensor type	order no.	accessory
06 31 01	15 A	NiCr-Ni (K)	08 07 02	clamp
06 31 02	15 A	Pt 100	07 99 01	plug for the connection to temp. sensor
			07 99 03	plug for analog output

Temperature sensors see page 57.



HTA

Temperature Display for HT 30 / HT 31

Technical Data

display:	LCD 3½ digit
case dimensions:	60 × 80 × 20 mm
case material:	plastic
connection:	with 3-pole socket to HT 30 / HT 31
connection line:	1 m

order no.
06 31 90

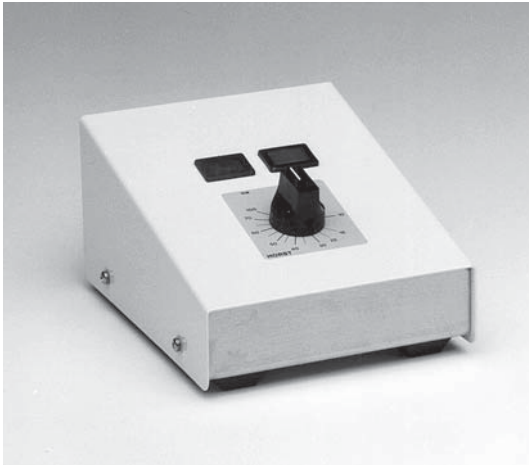

HLM

Electromechanical Power Controller

This electromechanical power controller for power adjustment of resistive loads allows a continuous power reduction from 70 % to 4 %. With mounting threads for fixing of clamps (accessory) on the rear.

Technical Data

power control:	by mechanical contact	protection category:	IP 30 (EN 60529)
switching power:	2300 W at 230 V	mains cable:	1.5 m exchangeable
main switch:	1-pole	case dimensions:	76 × 115 × 145 mm
power control:	4 ... 70, 100 %	case material:	coated steel, aluminum
safety class:	I		

order no. _____
04 12 01



HLE 10

Electronic Power Controller up to 10 A

This versatile power controller with electronic pulse control is suitable for continuous adjustment of resistive loads up to 2300 W. With mounting threads for fixing of clamps (accessory) on the rear.

HLE 10 can be combined with a contact thermometer according to DIN 41524.

Technical Data

power control:	with triac	protection category:	IP 30 (EN 60529)
switching power:	2300 W at 230 V	mains cable:	1.5 m exchangeable
main switch:	2-pole, illuminated	case dimensions:	76 × 115 × 145 mm
power control:	0 ... 100 %	case material:	coated steel, aluminum
safety class:	I		

order no. _____
04 10 01

order no. _____ accessory
08 07 02 clamp
07 99 02 jumper (spare part)



HLE 16

Electronic Power Controller up to 15 A

HLE 16 has the technical features of the HLE 10, but additionally allows switching power rates up to 15 A.

Technical Data

Differences to HLE 10:	switching power:	3450 W at 230 V
	mains cable:	1.3 m
	case dimensions:	75 × 165 × 145 mm

order no. _____
04 16 01

order no. _____ accessory
08 07 02 clamp
07 99 02 jumper (spare part)



HW 17

Limit Indicator for Mounting Rails

HW 17 is designed for mounting on top hat rails (TS35) in switching cabinets and housings. This microprocessor-controlled device monitors the temperature at a defined measuring point. Display of actual or limit value. There are two buttons on the front for adjustment of limit value and device setup.

Depending on the configuration, the relay (change-over contact) switches self-locking or resetting. Self-locking can be time-delayed. The lock is released by pressing the reset key on the device or by disconnecting from the power supply. The operating status is indicated with a LED. The relay switches ohmic loads 1-pole up to 250 VAC, 3 A, we recommend using external contactors or relays controlled by HW 17. Wiring with convenient screw terminals.

Technical Data

device type:	limit value controller
input:	Pt 100 (2 or 3 wire), NiCr-Ni, Fe-CuNi (L) and (J), PtRh10-Pt (S), 0(4) ... 20 mA, 0 ... 10 V and other thermocouples
limit range:	-100 ... 1600 °C depending on sensor type
limit value adjustment:	with buttons on the front
display:	digital temperature or limit value display, LED for operating-status indication
output:	relay (change-over contact)
switching power:	250 V / 3 A
protection category:	IP 20
mounting:	on 35 mm mounting rails
dimensions:	22.5 × 75 × 105 mm

order no.	nominal voltage
06 04 27	230 VAC
06 04 28	24 VDC



HT 55

Self-Optimizing Microprocessor Regulator

Small format powerful regulator at a reasonable price.

After mounting into a front panel, the regulator front will achieve protection category IP 65. For measuring value input you can choose from 15 sensor types and linear signals. The regulator output is designed to trigger an electronic relay. Two further relay outputs can be used as alarm contacts or for direct switching of small loads. The "self-optimization" function determines the optimal regulating parameters for the heating task – on demand, the setpoint is approached with a ramp function. HT 55 can be operated with 4 buttons or with a service interface and optional Windows software. With LED display for actual value, setpoint value, control deviation and switching state of the outputs. The regulator configurations can be protected using passwords.

With order number 06 55 15 current monitoring can be realised.

Prepared for triggering an electronic relay. The available relay contact is used as an alarm contact for current control.

Technical Data

Two-position / three-position regulator	
regulating characteristics:	P / PD / PID
nominal voltage:	100 ... 240 V AC
regulator outputs:	2× relay, 1× logic, configurable
programmable functions:	self-optimization, auto optimization, soft start
power control:	logic output: 10 VDC Min., Rout = 100 Ω (6 V / 20 mA) relay: 5 A / 250 VAC, cosφ = 1
current transformer input:	50 mA ac, 50/60 Hz, Ri = 2 Ω
switching power at 230 V~:	3 A
accuracy class:	0.25 %
protect. category front cover:	IP 65 (EN 60529)
cross section clamps:	2.5 mm ²
case dimensions:	48 × 48 × 110 mm

order no.	
06 55 10	HT 55
06 55 50	cable + converter RS 232 / TTL configuration software for Windows included
06 55 15	HT 55 with option "heating current supervision"
06 55 60	current transformer for 06 55 15



HT 56

Self-Optimizing Microprocessor Program Regulator

HT 56 has the characteristics of HT 55, which are required for a comfortable installation and an exact operation of a control circuit.

With the following functions, even more complex applications can be operated:

- external setpoint adjustment via current or voltage signal
- 2 configurable analog outputs for reading different process values for e.g. master/slave combinations to control other devices.
- 1 - 4 setpoint programs for up to 12 steps. One "step" consists of a temperature ramp and the hold time.

The setpoint programs can be chosen via 2 digital inputs and can be operated, e.g. with the commands "start", "stop" and "reset".

Optionally the regulator can also be operated using a standard RS 232/485 interface or with a service software and a connection cable for the configuration.

Technical Data

Two-position / three-position regulator

regulating characteristics:	P / PD / PID
nominal voltage:	100 ... 240 V AC
measuring-value inputs:	15 different thermoelements, Pt 100, DC linear signals, customer-specific linearization adjustable into 32 segments.
regulator outputs:	2x relay, 1x logic, configurable
programmable functions:	self-optimization, auto optimization, soft start
power control:	logic output: 11 Vdc, Rout = 220 Ω (20 mA, max. 6 V) relay: 5 A / 250 V, cosφ = 1
program function:	12 steps organized in max. 4 programs
accuracy class:	0.2 %
regulation boost:	-100 ... 100 %
protect. category front cover:	IP 65 (EN 60529)
cross section clamps:	2.5 mm ²
case dimensions (hwxwd):	96 x 96 x 113 mm

order no.

06 56 10	HT 56
06 56 50	connection cable, configuration software for Windows included



pic.: HT 560

HT 550 / HT 560

HT 55 / HT 56 in Table Housing

The microprocessor regulators HT 55 and HT 56 described on pages 46 and 47 are designed for front panel integration and have to be wired with additional components for operation.

HT 550 / HT 560 have integrated regulator electronics ready for operation in a table housing. With an integrated electronic relay, up to 16 A current load can be switched. An additional contactor, triggered by an alarm contact, switches off the heating in case of a defect of the electronic relay. The status is displayed as "error".

The heating is connected with a three-pole plug, a suitable mating plug is included in the scope of delivery. As an alternative, an additional current supervision can be integrated. In case of a deviation from the adjusted current value, this status is displayed as "error" and the heating is cut off from the net by the contactor.

Additional technical data to HT 55 / HT 56:

power control:	solid state relay
switching power:	3600 W AC 1 (16 A)
protection class:	I
protection category:	IP 30 (EN 60529)
housing:	table housing
housing dimensions:	260 x 180 x 240 mm

order no.

06 56 70	table housing with integrated HT 56 regulator electronic (see page 47)
06 56 71	like 06 56 70 but with additional current supervision
06 56 50	accessories: connecting cable with service software for Windows
06 55 70	table housing with integrated HT 55 regulator electronic (see page 46)
06 55 71	like 06 55 70 but with additional current supervision
06 55 50	accessories: connecting cable with service software for Windows



Temperature Regulators



pic.: HT MC11 model 06 20 60
connection via cable glands



pic.: HT MC11 model 06 20 66
connection via multipole socket type "Schaltbau M1"
for 2 sensor inputs

HT MC11

Microprocessor Temperature Regulator

HT MC11 is a temperature regulator ready for operation with temperature supervision independent from regulation using an own temperature sensor input and heating current monitoring function (option). The compact aluminum housing with protection category IP 65, high configurability as well as various connection options and functions enable a wide range of uses for temperature control and monitoring of electrical heating elements. For a fast and easy start-up, the HT MC11 is delivered pre-configured and adapted to its intended use.

Functions and features:

- Housing: Powder coated aluminum, protection category IP 65
- Control electronics: Two-position-regulator, PID control characteristics
- Nominal voltage: 230 VAC, 48...63 Hz, other voltages are available as an option
- Self-optimization: Automatic determination of control parameters (Autotune)
- Operation: Using keypad
- Temperature supervision: Temperature supervision with second sensor input, adjustable limit value, two-pole disconnection of heating voltage
- Connections: Heating and temperature sensor connection via multipole sockets or cable glands, connection board with spring terminals inside the housing
- Switching power: Up to 3450 Watt (at 230 VAC), electronically switched
- Temperature sensor: Independently selectable for regulation and supervision
Resistance sensor: Pt100, Ni120, Pt1000
Thermocouple: Fe-CuNi (L), Fe-CuNi (J), NiCr-Ni (K), PtRh-Pt (S), NiCr-NiSi (N)
- Potential-free switching: Heating voltages 24-250 VAC (10 A or 15 A depending on model) can be switched independently from the auxiliary voltage of the control electronics.
- Program function: 6 * ramp time + hold time
- Softstart function: For smooth heating-up
- Alarm relay: Potential-free normally open contact, 250 V, max. 2 A
- Output ratio display: Shows the present calculated output ratio in 0...100 %
- Max. output ratio limitation: Reduces the connected heating output
- Manual output ratio mode: In case of sensor break, operation continues with last calculated output ratio
- Manual mode: Device operates as a power controller
- Operation lock: Available on three levels
- Setpoints: Setpoint 1, setpoint 2 (can be activated by external contact), external setpoint (only for option „analog input/output“)
- Second parameter set: Possible (can be activated by external contact)
- CE marking: EMV according to 2004/108/EG; EN 61326-1, Electrical safety: EN 61010-1

order no.	switching power	connection to heating via	potential-free switching	current monitoring	RS485	analog input/ output	dimensions h x w x d [mm]
				order no.	order no.	order no.	
06 20 60	10 A	cable glands	yes	---	06 21 50	06 21 52	165 x 127 x 75
06 20 61	10 A	multipole socket type "Binder S693" for 1 sensor input	no	---	06 21 50	06 21 52	165 x 127 x 75
06 20 62	10 A	multipole socket type "Schaltbau M1" for 2 sensor inputs	no	---	06 21 50	06 21 52	165 x 127 x 75
06 20 65	15 A	cable glands	yes	06 21 51	06 21 50	06 21 52	222 x 146 x 82
06 20 66	15 A	multipole socket type "Schaltbau M1" for 2 sensor inputs	no	06 21 51	06 21 50	06 21 52	222 x 146 x 82
order no. options							
06 21 50	serial interface RS485, Modbus-RTU						
06 21 51	heating current monitoring (alarm output)		Resulting in mechanical and two-pole disconnection of heating voltage With this option, the alarm relay is not available.				
06 21 52	analog input/output		Setpoint adjustment 0...10 VDC, analog process value output 0...10 VDC, or analog output ratio 0...10 VDC (continuous controller)				
order no. accessories							
07 99 04	BS 693 multipole plug "Binder S693"		for 06 20 61				
07 99 18	SSM-1 multipole plug "Schaltbau M1"		for 06 20 62 and 06 20 66				

On request, we also mount the regulator HT MC11 in other housings, depending on requirements



HT MC11 P15

Microprocessor Temperature Regulator for Three-Phase System

HT MC11 P15 is a temperature regulator ready for operation with temperature supervision independent from regulation using an own temperature sensor input. It has the same regulating characteristics as HT MC11 and is designed for electrical heatings in three-phase systems. The regulation electronics are protected from mechanical damage by the robust powder-coated aluminum housing. Electrical connection with cable glands.

Technical data in deviation to HT MC11

switching power: 10.3 kW at AC 1
 nominal voltage: 230/400 V 3/N 4862 Hz
 main switch: 3-pole, lockable

order no.	load current max.	connection heating	dimensions h x w x d [mm]	options, description see page 48			
				potential-free switching	current monitoring	RS485	analog input/output
06 20 67	3x15 A	cable glands	250x250x100	yes	---	06 21 50	06 21 52

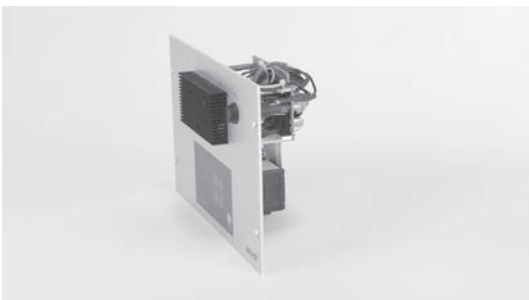

HT MC11 S19

Microprocessor Temperature Regulator integrated in 1/2 19" Front Panel for System Housings

HT MC11 S19 is a ready-wired component with the same regulating characteristics as HT MC11. Before start-up it must be installed and connected into a suitable system housing. In addition to the regulation electronics it has a solid state relay for switching the load, a 2-pole mechanical relay to cut off the heating from the mains in case of an error and an exchangeable fuse on the front. A connection board on the rear allows easy connection with spring terminals. Also available for several control circuits or wired ready for operation in a table or wall housing.

Technical data in deviation to HT MC11

protection category: IP 00
 material front panel: aluminum anodized

order no.	load current max.	connection heating	dimensions h x w x d [mm]	options, description see page 48			
				potential-free switching	current monitoring	RS485	analog input/output
06 20 69	15 A	terminals	177x270x100	yes	06 21 51	06 21 50	06 21 52



example: 3 control circuits in table housing

Model for integration in 19" rack 4HE, 42TE

order no.	load current max.	connection heating	dimensions h x w x d [mm]	options, description see page 48			
				potential-free switching	current monitoring	RS485	analog input/output
06 20 99	15 A	terminals	174x213x100	yes	06 21 51	06 21 50	06 21 52



HT MC11 T15

Microprocessor Temperature Regulator in Table Housing

HT MC11 T15 is a temperature regulator ready for operation in a versatile table housing. It has the same regulating characteristics as HT MC11 and can be used with different electrical heatings. The temperature supervision function using a second temperature sensor enables to monitor the limit temperature of the heating element and to place the sensor at an important position of the component or inside the medium. In case of higher demands on control systems some helpful features can be used, e.g. self-optimization function, output ratio limitation and programming function. The RS485 interface option and the analog input/output option are available for communication with external devices.

Technical data in deviation to HT MC11

main switch: 2-pole, illuminated
 protection category: IP 30

order no.	load current max.	connection heating	dimensions h x w x d [mm]	options, description see page 48			
				potential-free switching	current monitoring	RS485	analog input/output
06 21 20	15 A	terminals	109x189x240	---	---	06 21 50	06 21 52
06 21 21	15 A	plug connectors	109x189x240	---	---	06 21 50	06 21 52



Temperature Regulators



HT MC30

Basic Temperature Regulator for Mounting Rails

HT MC30 is a compact, basic regulating device with adjustable switching hysteresis, designed for mounting on a common 35 mm top hat rail in a housing or a switching cabinet.

For triggering a contactor or for direct switching of loads, a 1-pole potential-free relay (change-over contact) is available. The actual value is shown on a 3-digit LCD display.

Technical Data

two-position-regulator	
control system:	P
power control:	relay (change-over contact), 150000 switchings (AC 250 V / 10 A)
temperature sensor types:	Pt 100, PT 1000 (DIN EN 60751)
temperature range:	-200 ... +600 °C
degree of accuracy:	0.1 %
protection category:	IP 20 (EN 60529)
mounting:	on mounting rails 35 mm x 7.5 mm (EN 50022)
connection type:	terminals for wire cross sections up to max. 2.5 mm ²
case dimensions:	90 x 22.5 x 62 mm
case material:	polycarbonate

order no.	nominal voltage
06 23 70	230 V AC, 48 ... 63 Hz
06 23 75	12 ... 24 V DC +/- 15 % / 24 V AC +/- 15 %, 48 ... 63 Hz

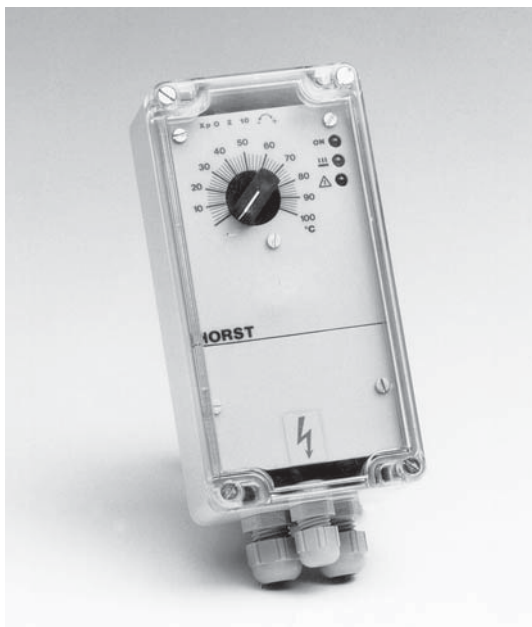

HT 22

Temperature Regulator with Splash-Proof Case

HT 22 is preferably used for simple regulation tasks or as an additional monitor. The regulator is equipped with a PD feedback and has an adjustable regulation amplifier for the adaptation to different controlled systems.

It has an electronic reference junction for thermoelements. The relay is equipped with a potential-free change-over contact. As the number of switchings is limited, the abrasion of the relay contacts is reduced. In case of an interrupted sensor line or if the sensor element is deficient, the device will immediately cut off. A control lamp indicates the failure.

The large connection space is equipped with self-locking terminals. According to VDE, a main switch must be superposed to the regulator.

Technical Data

two-position-regulator	
control system:	P-PD
power control:	relay
switching power at 230 V~:	2300 W
degree of accuracy:	1.5 %
control amplifier:	0, 1, 2, 5, 10 %
safety class:	II
protection category:	IP 65 (EN 60529)
cross section clamps:	2.5 mm ²
case dimensions:	55 x 80 x 160 mm
case material:	ABS

sensor: Fe-CuNi (J)	
range	order no.
0 ... 100 °C	06 22 01
0 ... 200 °C	06 22 02
0 ... 250 °C	06 22 11
0 ... 500 °C	06 22 03

sensor: NiCr-Ni (K)	
range	order no.
0 ... 100 °C	06 22 04
0 ... 250 °C	06 22 05
0 ... 500 °C	06 22 06
0 ... 1000 °C	06 22 07

sensor: Pt 100	
range	order no.
0 ... 50 °C	06 22 14
0 ... 100 °C	06 22 08
0 ... 200 °C	06 22 09
0 ... 250 °C	06 22 13
0 ... 500 °C	06 22 10

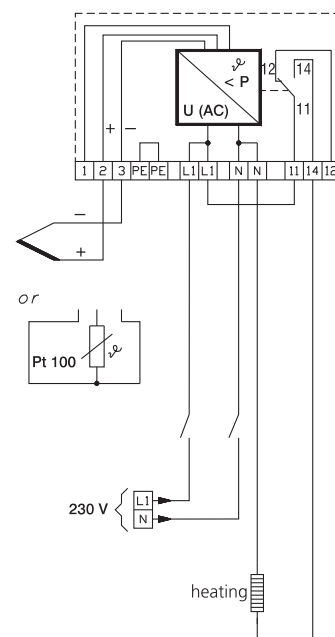
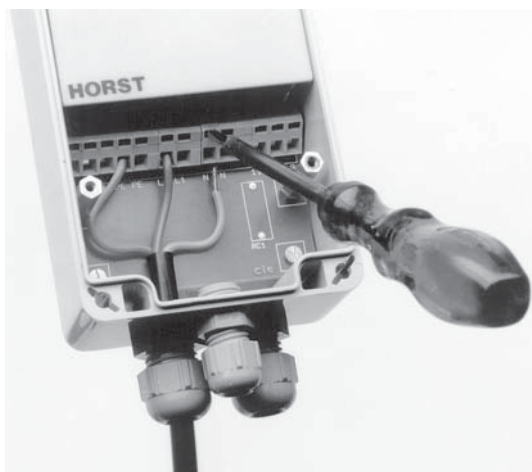



HT 20

Regulator with Common Mains / Sensor Connection

The HT 20 temperature regulator in a plastic case has one multi-pole plug socket for sensor and power connection. It is particularly suitable if regulator and heating (e.g. heating hoses, heating jackets, heating mats etc.) have to be disconnected quite fast.

HT 20 has a two-pole On-Off switch and two-pole power relay. As the number of switchings is limited, the abrasion of the relay contacts is reduced. In case of an interrupted sensor line or a sensor fault, the device cuts off immediately. A control lamp indicates the failure.

Technical Data

two-position-regulator		control amplifier:	2 %
control system:	P-PD	safety class:	II
power control:	relay	protection category:	IP 50 (EN 60529)
switching power:	2300 W at 230 V~	power cable:	1.3 m
power switch:	all-pole, unlit	case dimensions:	55 × 80 × 160 mm
degree of accuracy:	2.5 %	case material:	ABS / polycarbonate

sensor: Fe-CuNi (J)

order no.	range
06 20 01	0 ... 100 °C
06 20 02	0 ... 200 °C
06 20 11	0 ... 250 °C
06 20 03	0 ... 500 °C

sensor: NiCr-Ni (K)

order no.	range
06 20 04	0 ... 100 °C
06 20 05	0 ... 200 °C
06 20 12	0 ... 250 °C
06 20 06	0 ... 500 °C
06 20 07	0 ... 1000 °C

sensor: Pt 100

order no.	range
06 20 08	0 ... 100 °C
06 20 09	0 ... 200 °C
06 20 13	0 ... 250 °C
06 20 10	0 ... 500 °C

order no.	accessories
07 99 04	plug set HT 20



HTU

Universal Regulator with Sensor

This basic and reasonably-priced temperature regulator is suitable for monitoring solid, liquid and gaseous media.

Technical Data

nominal voltage:	230 V~ +10 / -15 %, 48 - 62 Hz
max. switching current:	16 A / 250 V
switching power:	3600 W
admissible ambient temperature:	-10 ... 50 °C
switching temperature difference:	approx. 1 - 5 K
contact (relay contact):	1 change-over contact, potential-free
electrical connections:	screwed connections
set point adjustment:	under case lid
sensor (self-monitoring):	PTC
case material:	plastic
protection category:	IP 65
weight (without sensor):	approx. 440 g

order no.	range	sensor (cable length / material)
06 12 30	-40 ... 20 °C	1.5 m / silicone
06 12 31	0 ... 60 °C	4.0 m / PVC
06 12 32	40 ... 100 °C	1.5 m / silicone
06 12 33	100 ... 160 °C	1.5 m / silicone

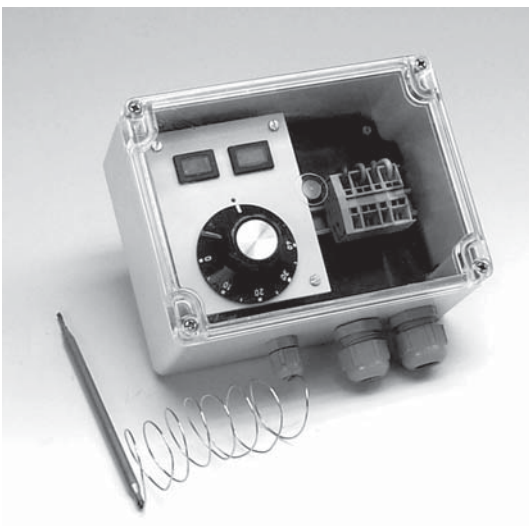

HTK

Capillary Tube Regulator

This regulator is suitable for simple temperature monitoring or temperature regulation, for example frost protection or heating rainwater gutters.

Technical Data

two-position-regulator	
control system:	P
switching hysteresis:	5 K
power control:	skip contact
switching power at 230 V~:	3600 W AC 1 (16 A)
degree of accuracy:	5 %
safety class:	I
protection category:	IP 65 (EN 60529)
cross section clamps:	2.5 mm ²
case dimensions:	120 × 160 × 75 mm
case material:	ABS, polycarbonate

order no.	range
06 12 01	0 ... 40 °C
06 12 02	0 ... 85 °C
06 12 03	50 ... 250 °C

Temperature Regulators

HT MC20, HT MC22, HT MC24, HT MC25 Multi-Zone Temperature Regulators for Integration in Switching Cabinets

The compact design allows from 2 to 256 control circuits to be operated. For selection of the standard options please refer to the order code on page 53.

General features of series HT MC20, HT MC22, HT MC24, HT MC25:

2-position and 3-position regulator (configurable)

Adjustment mode programmable: PD/I (PID modified), P, D, I parameters can be adjusted separately

Self-optimization of control parameters: For automatic adaptation to the control circuit

Control outputs: Bistable voltage signal 0/18 VDC, 10 mA for common solid state relays, see page 56

Alarm contacts: In standard, two alarm contacts are available (accumulative contacts). The triggering of the alarm can be determined for each control circuit: among others as limit value, signal contact relative to the setpoint or as limit comparator with a supervised temperature range.

Programmable for each control zone: Sensors (thermoelements, Pt 100), actual value offset adjustment, rising and falling setpoint ramps, 2nd setpoint, copy function for adjusted values of the control circuit.

Connection technology: Terminal blocks

Heater current control: This option can be used to operate several control circuits electrically parallel connected in one control zone. Only one transformer (see page 53) per phase is required. Monitoring includes heater current drop-out, heater current undershoot, partial failure and short circuit in the power element of the semiconductor relay.

Interface / field bus connection: Serial interfaces (RS 485, RS 232-C, TTY 0/20 mA), Profibus (DP), CANopen Device Profile: CiA DS-404

On demand these devices are available with control outputs by mechanical relays, analog inputs 0 ... 10 VDC, add-on software, regulating modes "3-position regulator" (heating – off – cooling) and wired ready-for-operation.



HT MC20

Multi-Zone Regulator in compact DIN Format

This reasonably-priced, compact model is suitable for applications, where adjusted values are not changed very often and all controlled heatings have not to be monitored simultaneously.

Model-specific technical data (general technical data see above)

product types: for 2, 4, 6, 8 or 10 control zones
housing: 7 segment display
case: DIN format 96 × 96 mm



HT MC22

Multi-Zone Regulator System for up to 256 Control Zones

This compact device is suitable for applications where control and operating units are separate. Once adjusted, the device works independently as a "black box".

For communication, several interfaces are available.

The system can be upgraded up to 256 control zones.

Model-specific technical data (general technical data see above)

product types: for 4, 6, 8, 10 or 16 control zones,
cascadable up to 256 control zones

operation: external operating unit or PC
housing: 125 × 105 × 125 mm for 35 mm DIN rail



pic.: operating unit (option)

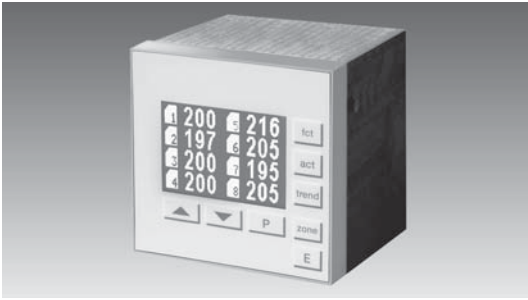

pic.: HT MC24



pic.: HT MC25

HT MC24/HT MC25

Models with LCD Display

Clear text enables convenient operation. Language: English or German.

The large display allows several views of the controlled heatings, e.g.: upper-case display of all actual values, contrast display of actual values and setpoints, tendency display with overview of set alarms, "process view" with simultaneous display of actual value, setpoint, percentage value, alarm state, current (if option is selected), zone info or as writer function with graphical display of the temperature profile during a period in the past.

HT MC24

Model-specific Technical Data (General Features on page 52 at the top)
 product types: for 4, 6 or 8 control zones
 case: DIN format 96 × 96 mm

HT MC25

Model-specific Technical Data (General Features on page 52 at the top)
 product types: for 8, 10, 12 or 16 control zones
 case: DIN format 192 × 96 mm

order no. code HT MC20, HT MC24, HT MC25

0	6	7	X	X	X	X	X
							1 power supply: 230 V AC
							2 power supply: 115 V AC
							3 power supply: 24 V AC
							5 power supply: 24 V DC
							0 without interface
							2 serial interface RS 232
							4 serial interface RS 485
							5 serial interface 0/20 mA
							7 CAN-open, CiA Device Profile DS-404
							9 Profibus-DP, EN50170
							0 standard
							5 with heater current monitoring (current transformer required)
0	1	MC24	4 zones	two-position-regulator;	control outputs: bi-stable voltage signal		
0	2	MC24	6 zones		ditto		
0	3	MC24	8 zones		ditto		
0	4	MC25	8 zones		ditto		
0	5	MC25	10 zones		ditto		
0	6	MC25	12 zones		ditto		
0	7	MC25	16 zones		ditto		
2	1	MC20	2 zones		ditto		
2	2	MC20	4 zones		ditto		
2	3	MC20	6 zones		ditto		
2	4	MC20	8 zones		ditto		
2	5	MC20	10 zones		ditto (only for Pt 100 2-wire)		

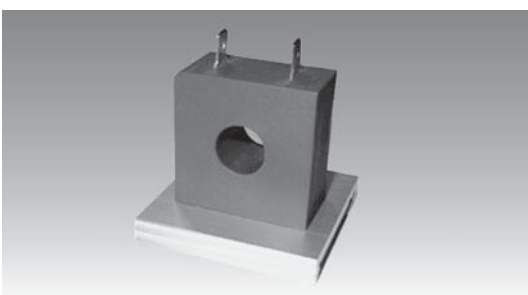

HTSW

One-Phase AC Current Transformer acc. to VDE 0414 EN 50178 (VDE0156), for mounting on 35 mm DIN rails.

Technical Data

input current: 50 A
 output current: 50 mA
 transformer ratio: 1:1000
 max. measuring overload: max. 20 %
 material: UL-V1

order no. _____
 06 70 05 00

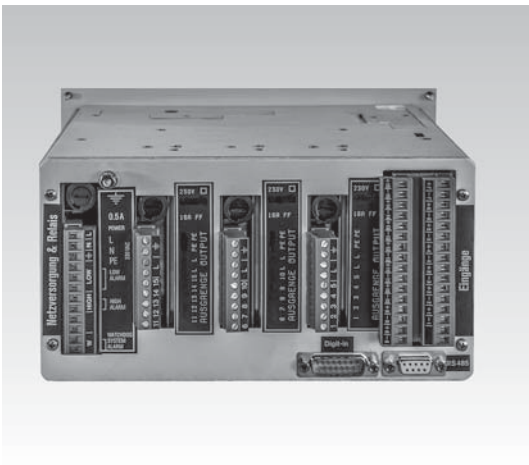

HT 61

Multichannel Microprocessor Regulator

This microprocessor-controlled multichannel regulator is available for 5, 10 or 15 temperature control circuits. Measuring values and operating messages of all control zones are displayed simultaneously. You can choose between the display of actual temperatures, set-point values, control deviations or control grades.

Each channel can be individually adjusted to requirements of the respective controlled system.

Up to 4 set points "SP1" ... "SP4" can be stored for each channel. In case e.g. "SP4" is selected, all assigned set points are activated with only one keystroke. This allows to adapt the temperature level of all connected control circuits easily and comfortably to different operating modes, e.g. change of material, temperature reduction during breaks in production.

Ramp functions for time-controlled achievement of set points can be programmed. Set points can be monitored for errors, e.g. low temperature, excess temperature, sensor break and sensor short circuit. Two potential-free contacts will trigger in case of error and the error message will be displayed.

Electrically insulated triacs can switch ohmic loads up to 5 A directly, or can switch final controlling elements e.g. solid state relays. HT 61 is equipped with a diagnostic program which can be started after initial installation or in case of errors. It performs plausibility checks and detects e.g. cable mistakes, polarity reversals, short circuits and cable breaks.

Each HT 61 channel can also be operated as a power controller without temperature measuring, the control grade is displayed in percent.

Technical Data

two-position-regulator / three-position-regulator, configurable for each channel

control system:	PI, PD or PID
nominal voltage:	230 V~ +5 % / -10 %, 20 VA
outputs:	1 triac for each output nominal voltage 42 V~ ... 230 V~ max 5 A per triac, max. 16 A per group of five and controlled case temperature < 60 °C
temperature sensor inputs:	NiCr-Ni – temperature range adjustable between 0 - 999 °C Pt 100 – temperature range adjustable between 0 - 250 °C
potential-free switching contacts:	1* excess temperature, relative to set point 1* low temperature, relative to set point 1* watchdog-function, absolute value each as combination alarm, max. 230 V~ / 3 A
terminals:	2.5 mm ² (detachable), interface socket
case:	metal housing
dimensions	height 3 HE – 128.4 mm
for 19" rack:	breadth 42 TE – 213 mm depth 255 mm incl. plug connectors
for switching cabinet:	height 128.4 mm breadth 230 mm depth 255 mm incl. plug connectors cut-out: HxB 114.4 mm x 214 mm
interface:	RS 485 included
ambient temperature:	max. 45 °C
weight:	approx. 2.5 - 3 kg depending on type

HT 61 for 19" rack			HT 61 for switching cabinet		
order no.	number of channels	sensor input	order no.	number of channels	sensor input
06 61 05	5	Pt 100	06 61 06	5	Pt 100
06 61 10	10	Pt 100	06 61 11	10	Pt 100
06 61 15	15	Pt 100	06 61 16	15	Pt 100
06 61 20	5	NiCr-Ni (K)	06 61 21	5	NiCr-Ni (K)
06 61 25	10	NiCr-Ni (K)	06 61 26	10	NiCr-Ni (K)
06 61 30	15	NiCr-Ni (K)	06 61 31	15	NiCr-Ni (K)

Additional features on request:

nominal voltage control electronics:	115 V~, 24 V~, 24 V=
triac outputs for nominal voltages:	24 V~, 24 V=
sensor inputs:	Fe-CuNi, Ni120, 0..10 V, 4..20 mA
interfaces:	RS 232, RS 422



example 1

Examples of Use

We also offer individually designed temperature regulators according to customer requirements in combination with further components.

Starting with specifying the number of required control circuits, we recommend suitable regulating electronics and choose a housing, e.g. for wall mounting, desktop model, mobile cabinet or 19" rack for housing systems.

For the technical layout, the switching currents of the desired application are considered.

Design options can be specified together with the customer, e.g.: position of heater connection (at the front, the rear side or the side), type of heater connection (cable screwings or plugs).

Labelling on the housing can be specified by the customer with application-specific names and signs.

Below some examples:



example 2

Example 1: HT MC25 for 12 control zones as compact temperature measuring device.

2 control circuits are actively used for the regulation of one heating. The 10 remaining control circuits are applied to record the temperatures at different measuring points.

Documentation with PC interface.

Example 2: Temperature regulator with 15 control zones for a pipe heating with additional electromechanical temperature limitation.

Start / reset of each control circuit on the front panel with display of operating status.

Example 3: Mobile 19" cabinet with 16 control circuits for mobile use in bake-out of high-vacuum components.

Example 4: HT MC25 for 16 control zones with additional temperature limitation for each heating circuit in a robust and maintenance-friendly switching cabinet.

The load is switched with electronic relays, mechanical contactors cut the heating circuits from the mains in case of error. Operation and display of most important operating states on the front.



example 3



example 4

Temperature Regulators



BS 678

Multipole Plug

Six-pole plug, suitable for sensor plug sockets of HORST temperature regulators. For retrofitting temperature sensors, connection examples are enclosed.

order no.
07 99 01

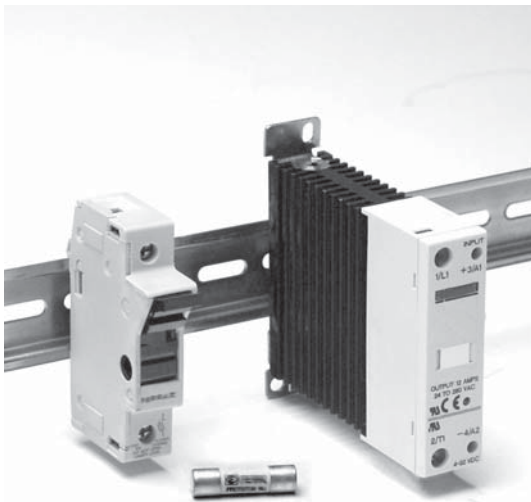

pic.: fuse carrier ST 10, fuse

pic.: solid state relay HER 20 A

HER 20

Solid State Relay with Heatsink for DIN Rail

This compact electronic single-phase relay switches loads up to 30 A. It is non-wearing and can be mounted easily on a DIN rail or a mounting plate. The relay must always operate in combination with a suitable external short-circuit protection fuse (see ST 10 fuse carrier).

Technical Data

	HER 20 A	HER 20 D
load voltage:	600 VAC	600 VAC
load current max.:	20 A AC 1	30 A AC 1
control voltage:	180 ... 280 V AC/DC	4 ... 32 VDC
operating temperature:	-20 °C ... +80 °C	-30 °C ... +70 °C
dimensions:	89 × 22.5 × 121 mm	103 × 22.5 × 103 mm
zero voltage indication, LED display for input status		

order no.	type	control voltage
06 90 14	HER 20 A	180 .. 280 V AC/DC
06 90 45	HER 20 D	4 .. 32 VDC

ST 10

Single-Phase Fuse Carrier for DIN Rail

Technical Data

for fuse:	10.3 × 38 mm	nominal current:	max. 32 A
nominal voltage max.:	690 VAC/440 VDC	dimensions:	18 × 81 × 58 mm

order no.	type
06 90 49	ST 10
06 90 13	FF spare fuse, 10.3 × 38 mm, 3 pcs., 25 A
06 90 50	FF spare fuse, 10.3 × 38 mm, 3 pcs., 20 A
06 90 53	FF spare fuse, 10.3 × 38 mm, 3 pcs., 10 A

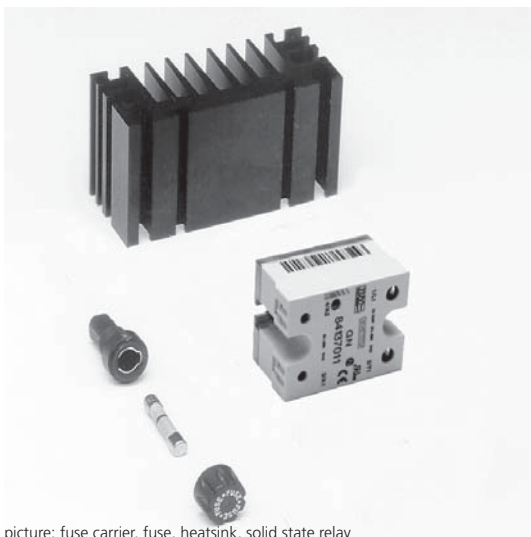

picture: fuse carrier, fuse, heatsink, solid state relay

HER 22

Solid State Relay for Surface Mounting

This compact electronic single-phase relay switches loads up to 25 A. It is non-wearing and must always operate in combination with a suitable external short-circuit protection fuse.

Technical Data

load voltage:	230 VAC
load current:	25 A AC 1 (maximum load)
operating temperature:	-20 °C ... +70 °C
dimensions:	58.2 × 44.8 × 28.8 mm
zero voltage indication, LED display for input status	

order no.	control voltage
06 90 01	3 ... 32 VDC
06 90 03	20 ... 280 VAC

Accessories for Solid State Relay

order no.	description
06 90 05	cooling element, dimensions: 96 × 75 × 41 mm, thermal resistance 0.7 ... 2.0 K/W
06 90 02	fuse set for solid state relay: fuse carrier (protection category IP 67) for front panel mounting and FF 16 A fuse (6.3 × 32)
06 90 04	spare fuse FF 16 A, 5 pcs.

Note:

There is residual current in solid state relays. Therefore a main switch or a contactor should be superposed.

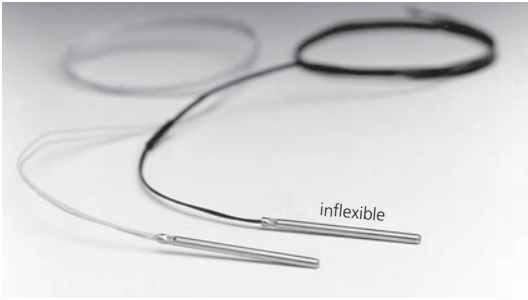

Pt 100 Insertion Sensor

with connecting cable 1 m, PTFE insulated (500 °C types: insulated with glass fiber)

with plug *	without plug	max. operating temp.	sensor dimensions	coat material
order no. 07 03 01	order no. 07 03 02	250 °C	Ø 3.0 × 30 mm	1.4571
07 03 08	07 03 07	500 °C	Ø 4.0 × 50 mm	1.4571



Mantle Pt 100

bendable tip, with connecting cable 2 m

with plug *	without plug	max. operating temp.	connecting cable	sensor dimensions	coat material
order no. 07 02 51	order no. 07 02 50	500 °C	PVC	Ø 3.0 × 300 mm	1.4541
07 02 56	07 02 55	500 °C	silicone	Ø 3.0 × 300 mm	1.4541
07 02 45	07 02 44	600 °C	silicone	Ø 1.5 × 300 mm	1.4541



Pt 100 Handheld Sensor

with connecting cable 1.5 m, silicone-insulated

order no.	sensor type	max. operating temp.	sensor dimensions	coat material	plug *
07 04 02	1 × Pt 100	450 °C	Ø 3.0 × 160 mm	1.4571	yes
07 04 03	1 × Pt 100	450 °C	Ø 3.0 × 250 mm	1.4571	yes
07 04 07	1 × Pt 100	450 °C	Ø 3.0 × 500 mm	1.4571	yes
07 04 05	2 × Pt 100	450 °C	Ø 6.0 × 160 mm	1.4571	yes
07 04 04	2 × Pt 100	450 °C	Ø 6.0 × 250 mm	1.4571	yes



Pt 100 Screw-On Sensor

Embedded in heat-conduction paste in a protection tube with square cross-section (5.5 × 5.5 mm², length 25 mm) with through hole: Ø 4.2 mm.

Connecting cable 2.5 m, PTFE insulated.

order no.	sensor type	max. operating temp.	sensor dimensions	coat material	plug
07 03 50	Pt 100	250 °C	5.5 × 5.5 × 20 mm	brass	no



Pt 100 Fixed on Pipe Clamp

For temperature measurement on pipes up to +350 °C. The tip has direct contact to the pipe for fast and exact measuring. Stainless steel screw clamp, connection line 2 m with wire end sleeves. Tolerance class B acc. to DIN EN 60751.

Insulation connection line: PTFE			Insulation connection line: glass fiber		
order no.	span Ø	temperature range	order no.	span Ø	temperature range
07 02 60	16 - 25 mm	-50 ... +250 °C	07 02 70	16 - 25 mm	-50 ... +350 °C
07 02 62	25 - 40 mm	-50 ... +250 °C	07 02 72	25 - 40 mm	-50 ... +350 °C
07 02 64	40 - 80 mm	-50 ... +250 °C	07 02 74	40 - 80 mm	-50 ... +350 °C
07 02 66	80 - 100 mm	-50 ... +250 °C	07 02 76	80 - 100 mm	-50 ... +350 °C

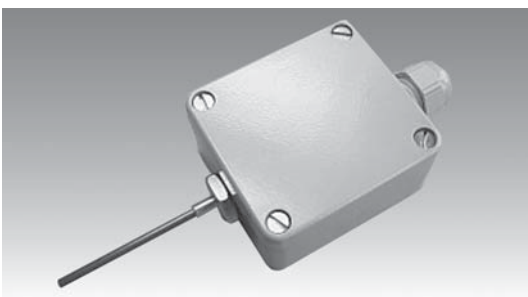

Pt 100 for Air Measuring

Pt 100 sensor to measure air temperature inside or outside. PVC housing (64 × 58 × 34 mm) splash-proof according to IP 65, cable connections inside the housing. Sensor pipe Ø 3 × 50 mm, mantle material 1.4571. Temperature range: -50 ... +50 °C.

order no.	
07 02 79	Pt 100 sensor 2-conductor, without connection line
07 02 80	connection line, running meter

* Temperature sensors with plug are ready for connection to temperature regulators that are equipped with a sensor socket type Binder 678, 6-pole.

Temperature Sensors



Mantle Thermocouples

Mineral insulated, bendable tip, solderable. Particularly suitable for high temperatures, liquids and aggressive environments. 2 m connecting cable.

with plug *		without plug		max. operating temp.	sensor dimensions	coat material
order no.	order no.	sensor type				
07 02 06	07 02 09	NiCr-Ni (K)		1000 °C	Ø 1.0 × 500 mm	2.4816 (Inconel)
07 02 29	07 02 28	NiCr-Ni (K)		1000 °C	Ø 1.0 × 1000 mm	2.4816 (Inconel)
07 02 07	07 02 10	NiCr-Ni (K)		1000 °C	Ø 1.5 × 80 mm	2.4816 (Inconel)
07 02 25	07 02 24	NiCr-Ni (K)		1000 °C	Ø 1.5 × 150 mm	2.4816 (Inconel)
07 02 02	07 02 04	NiCr-Ni (K)		1000 °C	Ø 1.5 × 250 mm	2.4816 (Inconel)
07 02 16	07 02 15	NiCr-Ni (K)		1000 °C	Ø 1.5 × 500 mm	2.4816 (Inconel)
07 02 08	07 02 11	NiCr-Ni (K)		1000 °C	Ø 1.5 × 1000 mm	2.4816 (Inconel)
07 02 13	07 02 05	NiCr-Ni (K)		1000 °C	Ø 1.5 × 1500 mm	2.4816 (Inconel)
07 02 01	07 02 03	Fe-CuNi (J)		600 °C	Ø 1.5 × 250 mm	1.4541 / 1.4571



Thermocouple Flat Sensor

with connecting cable 1.5 m, silicone-insulated

with plug *		without plug		max. operating temp.
order no.	order no.	sensor type		
07 01 01	07 01 03	Fe-CuNi (J)		500 °C
07 01 02	07 01 04	NiCr-Ni (K)		500 °C

Accessories

Compensating Conductors for Thermocouples

For extension of the above temperature sensors. Construction: silicone / silicone-insulated, 2 × 0.25 mm², diameter: 5 mm.

order no.	sensor type
07 06 01	Fe-Cu-Ni (J)
07 06 02	NiCr-Ni (K)



Miniature Plugs for Thermocouples

Plugs with reverse polarity protection in heat-proof plastic housings, with contacts made of thermo material. Operating temperature: -100 °C ... +120 °C.

order no.	
07 99 30	plug NiCr-Ni (K), green according to DIN
07 99 31	socket NiCr-Ni (K), green according to DIN
07 99 35	plug NiCr-Ni (K), yellow according to IEC
07 99 36	socket NiCr-Ni (K), yellow according to IEC
07 99 29	strain-relief for cable of miniature plugs (suitable for plug and socket)

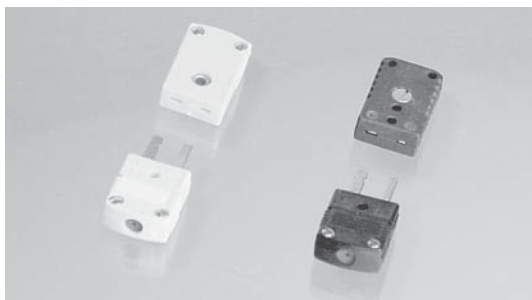

Compression Fittings for Thermocouples and Pt 100

To fix the installation depth of temperature sensors. Material: stainless steel.

Clamp ring, stainless steel: sensor position fixed. Cannot be moved after installation, temp. max. 500 °C, pressure resistance:
 Ø 1 - 3 mm: up to 120 °C 100 bar at 200 °C 70 bar > 300 °C 60 bar
 Ø 4 - 6 mm: up to 120 °C 80 bar at 200 °C 50 bar > 300 °C 40 bar

Clamp ring, PTFE: unscrewing and moving of sensor is possible, temp. max. 200 °C, pressure up to 6 bar.

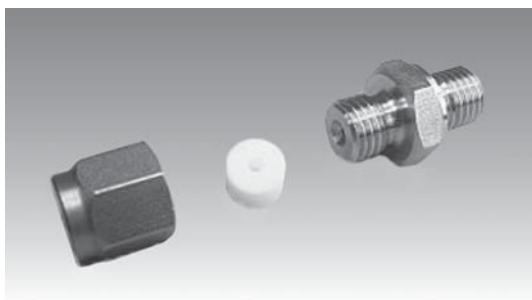

for Ø	thread	tool size	thread length	total length	clamp ring stainless steel	clamp ring PTFE
					order no.	order no.
1.0 mm	M 8 × 1	12	8 mm	23 mm	07 99 90	07 99 80
1.5 mm	M 8 × 1	12	8 mm	23 mm	07 99 92	07 99 82
3.0 mm	M 8 × 1	12	8 mm	25 mm	07 99 94	07 99 84
4.0 mm	M 10 × 1	14	8 mm	28 mm	07 99 96	07 99 86
6.0 mm	M 10 × 1	14	8 mm	30 mm	07 99 98	07 99 88

* Temperature sensors with plug are ready for connection to temperature regulators that are equipped with a sensor socket type Binder 678, 6-pole.

HORST Heating Mantles

Heating mantles are used for heating technical glass vessels such as round-bottomed flasks, beakers and flange vessels. Heating mantles are not ready-for-use. They are components for plant construction requiring additional operating elements. Safe operation is possible only after correct installation, taking different potential risks into account.

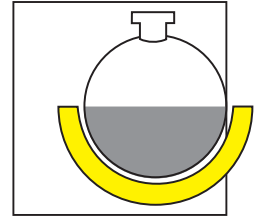

To select an appropriate heating mantle, the following questions are helpful:

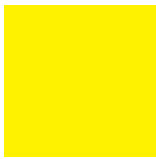

Which special requirements have to be met by the heating mantle?

For high demands regarding mechanical stability and for collecting leaking liquids, heating mantles with closed, formed heating trough made of corrosion-resistant metal are available. For special vessels, we offer reasonably-priced, handmade textile-glass types which are made to measure. Our heating mantles meet several requirements in technical centers and industry in sizes between 25 ml and 200 l.



Which temperature regulation is required?

Heating mantles have to be operated temperature-controlled, if necessary in combination with an additional temperature limiting devices. All heating mantles can be equipped with thermocouples or Pt 100 sensors. Heating mantles can be produced with several heating zones and temperature sensors. In combination with the appropriate number of temperature regulators, this guarantees a uniform and gentle heating.

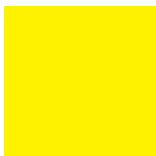

What are potential risks during operation of heating mantles?

Due to constructional reasons, the electrical insulation of heating mantles consists of heat-resistant textile glass. In case of permeating humidity, the electrical insulation characteristics will degrade. When integrating and connecting the heating mantle into a plant, measures must be taken to avoid the danger of an electric shock in case of permeating humidity. Heating mantles may only be operated in dry and clean environments. Use in explosive areas is not permitted. Heating mantles may only be operated in combination with residual current-breaking device or similar safety appliances.

Heating mantles bear the CE sign, among others according to DIN EN 60519-1 ("industrial electroheat").

On request, we will provide a CE Certificate of Conformity for the desired type.

We shall be glad to assist you in selecting appropriate components.

Heating Mantles



HMA-I - 400 °C

Heating Mantle for Industrial Use

Due to its solid design, this heating mantle for round bottomed flasks can be used in the production field as well as under working conditions with great demands on mechanical stability. The sealed heating trough is formed in one piece and is form-fittingly connected to the edge of the casing. It is moisture-proof, guarantees a homogenous heat distribution and has a protective earthing. The complete outer casing is made of 1.4571 stainless steel.

The heating mantle has to be operated temperature-controlled. Our HT MC 11 temperature regulator (page 46) is especially suitable for this purpose, however, it is also possible to use other already existing appropriate devices.

Features:

- 2 temperature sensors: 1x NiCr-Ni for temperature control of the heating surface, 1x Pt 100 for additional temperature control or limitation.
- For the electrical connection: IP 65 plastic casing for wiring, with terminals for mains and sensor connection. The terminal box is connected to the heating mantle with an insulated plastic hose (length 0.6 m).

Technical Data

nominal temperature:	400 °C	safety class:	I
nominal voltage:	230 V~	mains cable:	0.6 m
protection category:	IP 54 (EN 60529)		

order no.	liter	Watt
01 33 11	6	1500
01 33 12	10	1600
01 33 13	20	2200



HR - 500 °C

Heating Mantle with Moisture-Proof Heating Trough

The hemispherically formed heating surface is made of corrosion-proof and thermal conductive material. It is liquid-tight and earthed.

This heating mantle has to be connected to the temperature regulating device with two connection lines: one for the thermocouple and one for the two heating zones. Robust aluminum desktop housing with high-quality powder coating.

Technical Data

nominal temperature:	500 °C	protection category:	IP 32 (EN 60529)
nominal voltage:	230 V~	connection:	wire end sleeves
safety class:	I		

order no.	ml	Watt	order no.	ml	Watt
01 63 03	100	150	01 63 07	2000	720
01 63 04	250	220	01 63 09	4000	1200
01 63 05	500	320	01 63 11	6000	1500
01 63 06	1000	500			



HG - 450 °C

Glass Yarn Heating Mantle

This high-performance heating mantle can be fixed with a support ring. The heating conductor made of flexible glass yarn perfectly adapts to the glass flask.

The heating mantle has to be connected to the temperature regulating device with separate connection lines for thermocouple and heating zone. The electrical insulation is not humidity-proof and requires special safety measures during operation.

Technical Data

nominal temperature:	450 °C	protection category:	IP 30 (EN 60529)
nominal voltage:	230 V~	connection:	wire end sleeves
thermoelement:	NiCr-Ni (K)		

order no.	ml / l	Watt	order no.	ml / l	Watt	accessory: support ring
01 41 01	25	60	01 41 08	3	800	order no. ml / l
01 41 02	50	75	01 41 09	4	1000	08 01 03 100
01 41 03	100	150	01 41 10	5	1150	08 01 04 250
01 41 04	250	200	01 41 11	6	1400	08 01 05 500
01 41 05	500	300	01 41 12	10	2000	08 01 06 1
01 41 06	1	450	01 41 13	20	2750	08 01 07 2
01 41 07	2	700				08 01 09 4

HG heating mantles on demand also for temperatures up to 900 °C.

The glass flasks are not included in scope of delivery.

Please take note of our information on page 59.

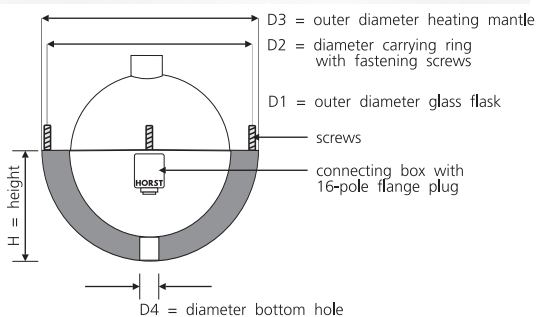

QHG - 450 °C

Heating Mantle up to 200 Liters

The heating surface of the heating mantle for glass flasks up to 200 liters is made of smooth glass-yarn fabric which is adapted to the shape of the flask. This heating mantle can be fixed e.g. in a supporting stand with four movable threaded bolts. Due to the heavy weight, the glass flask should be supported additionally.

Each heating zone has a NiCr-Ni (K) temperature sensor. The maximum operating temperature is 450 °C.

To allow easy maintenance and mounting, the heating mantle is equipped with a 16-pole industrial flange plug.

Technical Data

nominal temperature: 450 °C
 nominal voltage: 230 V / 400 V

type	size [l]	D1	D2	D3	D4	H	heating zones.	threads
QHG 020	20	365	500	520	100	290	3	4× M8 × 100
QHQ 050	50	510	640	660	100	360	3	4× M10 × 130
QHG 100	100	610	790	810	120	440	4	4× M12 × 130
QHG 200	200	760	940	960	120	510	4	4× M12 × 130

order no.	type	power [W]
01 16 01	QHG 020	2750
01 16 02	QHG 050	5500
01 16 03	QHG 100	7600
01 16 04	QHG 200	12200

Please note that there are many different flask types. We also offer standard OHG heating mantles for other common sizes, e.g. 20 liter flasks with a diameter of 350 mm, 50 liter flasks with a diameter of 490 mm or 200 liter flasks with a diameter of 750 mm.

Please ask for the order number before placing an order.

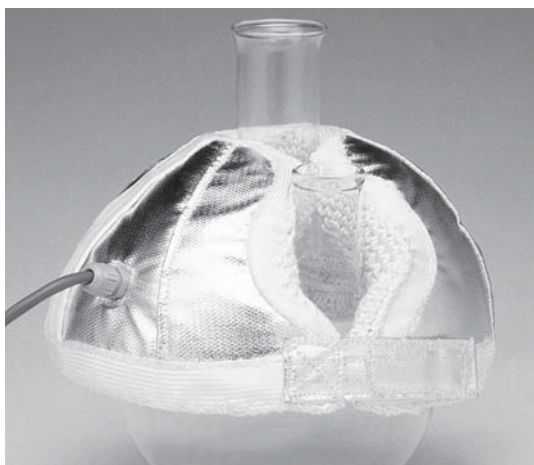

HI - 450 °C

Insulation Mantle

There are two types of HI mantles for the top of one-neck and two-neck flasks: heated or unheated. The electrical insulation of the heating surface in the heated version is not humidity-proof. This device requires special preventive measures. A NiCr-Ni (K) thermocouple is integrated.

Insulating Mantles for One Neck Flasks			Insulating Mantles for Two Neck Flasks		
series HI unheated		series HI heated	series HIZ unheated		series HIZ heated
order no.	ml / l	order no.	order no.	ml / l	order no.
03 11 04	250	03 12 04	03 13 04	250	03 14 04
03 11 05	500	03 12 05	03 13 05	500	03 14 05
03 11 06	1	03 12 06	03 13 06	1	03 14 06
03 11 07	2	03 12 07	03 13 07	2	03 14 07
03 11 08	3	03 12 08	03 13 08	3	03 14 08
03 11 09	4	03 12 09	03 13 09	4	03 14 09
03 11 10	5	03 12 10	03 13 10	5	03 14 10
03 11 11	6	03 12 11	03 13 11	6	03 14 11
03 11 12	10	03 12 12	03 13 12	10	03 14 12
03 11 13	20	03 12 13	03 13 13	20	03 14 13

Special types on request.

A	AB	19	Heating Hose - Pressure Hoses	36	KSV	19			
	ABF.....	19	Heating Hoses.....	33-42	L	Limit Value Controller	46		
	Accessories for Temperature Regulators	56	Heating Hose, Self-Limiting.....	41	M	Mantle Pt 100.....	57		
	Accessories for Temperature Sensors	58	Heating Hose with Exchangeable Inner Tube	39-40		MCC.....	18		
	Adhesive Tape.....	21	Heating Jackets.....	24-25		MEP.....	18		
	Aluminum Foil Adhesive Tape.....	21	Heating Mantle for Industrial Use.....	60		MG.....	18		
	Analysis Heating Hoses	39-41	Heating Mantle in Desktop Housing.....	60		Microprocessor Temperature Regulator	46-55		
	Analysis Heating Hose with Integrated Filter.....	39	Heating Mantles	59-61		Mineral-Insulated Heating Cables.....	11		
	Anti-Freeze Regulator	10	Heating Mantle up to 200 Liters.....	61		Miniature Plugs for Thermoelements.....	58		
	AS	20	Heating Mats.....	22		Mounting Accessories	17-21		
B	Bakeout Tent.....	4	Heating Plates.....	32		MSI.....	18		
	Barrel Head Heating Plate	27	Heating Tape in Slim Design.....	13	N	Needled Glass Fiber Mat	18		
	Barrel Heating.....	27	Heating Tapes, Heating Cables	5-16		NIL.....	21		
	Barrel Heating Ring	27	HER 20	56	P	Plastic Binders.....	19		
	Barrel Insulating Jacket.....	27	HER 22	56		Plug Connectors for Temperature Sensors	58		
	BCTEX Fabric	18	HFB.....	23		Porcelain Clamps	20		
	BCTEX Fabric Tape	17	HFH.....	23		Power Controller.....	45		
	BCTEX Fleece.....	18	HFI 20.....	27		Pt 100 Fixed on Pipe Clamp	57		
	BS 678.....	56	HG.....	60		Pt 100 for Air Measuring.....	57		
	BS 693.....	48	HI.....	61		Pt 100 Handheld Sensor.....	57		
C	Capillary Tube Regulator	51	High Temperature Heating Cable	14		Pt 100 Insertion Sensor	57		
	Cartridge Heaters.....	30-31	High Temperature Resistant Fabric.....	18		Pt 100 Screw-On Sensor	57		
	Cartridge Heaters Special Models.....	31	HIH.....	35		PTFE Heat Shrink Tubings.....	21		
	Circuit Breaker	20	HKPT	6	Q	QHG	61		
	Circulation Heaters	29	HKSI	6		Quartz Glass Fabric Hose.....	17		
	Compensating Conductors for Thermocouples..	58	HLE 10.....	45		Quick Lock for Tension Band	19		
	Compression Fittings for Temperature Sensors...	58	HLE 16.....	45	R	RCD (Residual Current Protective Device).....	20		
	Connecting Wire.....	21	HLM	45	S	Safety Transformer	16		
	Connection Box for Heating Tapes/Cables	10, 15	HLP	30		SCC	18		
F	Flange Heatings	23	HM 20 K.....	27		Self-Adhesive Foam Tape.....	18		
	Foam Tape, Self-Adhesive.....	18	HMA-I.....	60		Self-Limiting Heating Hose	41		
	FS	20	HMF	28		Self-Limiting Heating Tapes	7-8		
	Fuse Carrier	56	HMI	23		SGA.....	18		
G	GA.....	29	HMP	32		SGI	18		
	GAB.....	21	HMSG.....	22		SH	21		
	Gas Heaters	29	HMSQ.....	22		SIB.....	21		
	GB.....	17	HMST.....	22		Silicone Foam Hose	17		
	GBB.....	17	HMT	24		Silicone Glue.....	18		
	GBW.....	17	HR	60		Silicone Heating Mats	23		
	GCC.....	17	HS	14		SJ.....	17		
	GIB.....	21	HS 42	16		Slim Heating Tape	15		
	GKB.....	21	HSMV preconfigured.....	11		Solid State Relay	56		
	Glass Fabric Adhesive Tape.....	21	HSQ.....	14		SP	19		
	Glass Fabric Hoses.....	17	HSQ 42.....	16		Spacer Tape	19		
	Glass Fiber Cord.....	17	HSS.....	14		SPV.....	19		
	Glass Fiber Tape	17	HST.....	15		SSG	18		
	Glass Yarn Fabric.....	18	HST 42.....	16		SSM-1.....	48		
	Glass Yarn Fabric, coated with Aluminum	18	HSTD	15		ST 10.....	56		
	Glass Yarn Fabric, coated with Silicone.....	18	HT 20	51		ST 100/300/500	16		
	Glass Yarn Heating Mantle.....	60	HT 22	50	T	Temperature Display for HT 30 / HT 31	44		
	GSH.....	17	HT 30	44		Temperature Limit Indicator.....	46		
	GSI	17	HT 31	44		Temperature Regulators	10, 43-55		
	GSK.....	17	HT 55	46		Temperature Regulators - Accessories.....	56-58		
	GSO.....	17	HT 55 / HT 56 in Table Housing	47		Temperature Regulator with Sensor.....	51		
H	H 12	38	HT 56	47		Temperature Sensors	57-58		
	H 13	40	HT 61	54		Tension Band	19		
	H 13 A.....	39	HT 550	47		Terminal Box	20		
	H 13 B.....	41	HT 560	47		Thermal Insulating Jackets.....	26		
	H 13 C.....	40	HTA	44		Thermal Switches.....	20		
	H 14.....	42	HTK	51		Thermocouples	58		
	HB 20 K.....	27	HT MC11.....	48-49		TR 1208.....	10		
	HBQ.....	12	HT MC20.....	52		TS.....	20		
	HBRA - 65 °C.....	7	HT MC22.....	52		Tube Furnaces	28		
	HBRC - 85 °C.....	8	HT MC24.....	53	V	Velcro Fasteners.....	19		
	HBRT - 120 °C.....	8	HT MC25.....	53		VG.....	29		
	HBRT - 150 °C.....	8	HT MC30.....	50		VTB.....	10		
	HBRT - 200 °C.....	9	HTSW	53		VTH	10, 15		
	HBS.....	12	HTU	51		VTK 40/50/70	10		
	HBSI.....	13	HW	20	I	IM.....	21		
	HBSIE.....	13	HW 17.....	46		Industrial Hoses, Heated.....	42		
	HBST.....	13	K	KA.....	20	Information Sign "Electrical Heating"	20		
	HBV.....	12		KC.....	21	Insulating Hose	18		
	Heated Couplings	35		KG.....	20	Insulating Jackets.....	26		
	Heating Cables	14-16		KSI.....	18	Insulating Mat.....	18		
	Heating Cables by the Meter.....	6-7		KSP.....	19	Insulating Plates / Bulk Material.....	21		
	Heating Cables for 42 V.....	16				Insulation Mantle.....	61		
	Heating Cable with Special Steel Cover	11				ISM.....	26		
	Heating Hose - Armatures.....	36				L	Limit Value Controller	46	
	Heating Hose - Connections.....	35				M	Mantle Pt 100.....	57	
	Heating Hose - Construction.....	34					MCC.....	18	
	Heating Hose - Optional Equipment.....	37					MEP.....	18	
	Heating Hose - Outer Protective Hoses	37					MG.....	18	
							Microprocessor Temperature Regulator	46-55	
							Mineral-Insulated Heating Cables.....	11	
							Miniature Plugs for Thermoelements.....	58	
							Mounting Accessories	17-21	
							MSI.....	18	
							N	Needled Glass Fiber Mat	18
								NIL.....	21
							P	Plastic Binders.....	19
								Plug Connectors for Temperature Sensors	58
								Porcelain Clamps	20
								Power Controller.....	45
								Pt 100 Fixed on Pipe Clamp	57
								Pt 100 for Air Measuring.....	57
								Pt 100 Handheld Sensor.....	57
								Pt 100 Insertion Sensor	57
								Pt 100 Screw-On Sensor	57
								PTFE Heat Shrink Tubings.....	21
							Q	QHG	61
								Quartz Glass Fabric Hose.....	17
								Quick Lock for Tension Band	19
							R	RCD (Residual Current Protective Device).....	20
							S	Safety Transformer	16
								SCC	18
								Self-Adhesive Foam Tape.....	18
								Self-Limiting Heating Hose	41
								Self-Limiting Heating Tapes	7-8
								SGA.....	18
								SGI	18
								SH	21
								SIB.....	21
								Silicone Foam Hose	17
								Silicone Glue.....	18
								Silicone Heating Mats	23
								SJ.....	17
								Slim Heating Tape	15
								Solid State Relay	56
								SP	19
								Spacer Tape	19
								SPV.....	19
								SSG	18
								SSM-1.....	48
								ST 10.....	56
								ST 100/300/500	16
							T	Temperature Display for HT 30 / HT 31	44
								Temperature Limit Indicator.....	46
								Temperature Regulators	10, 43-55
								Temperature Regulators - Accessories.....	56-58
								Temperature Regulator with Sensor.....	51
								Temperature Sensors	57-58
								Tension Band	19
								Terminal Box	20
								Thermal Insulating Jackets.....	26
								Thermal Switches.....	20
								Thermocouples	58
								TR 1208.....	10
								TS.....	20
								Tube Furnaces	28
							V	Velcro Fasteners.....	19
								VG.....	29
								VTB.....	10
								VTH	10, 15
								VTK 40/50/70	10

All sales and deliveries are exclusively based on our general conditions of trade. Prices without obligation, ex works, excluding packing and VAT. Payable within two weeks from the date of invoice with 2 % discount or within 30 days without discount. Technical modifications subject to change.

Important Advice:

Our devices and components may only be installed or put into operation by qualified persons. We explicitly refer to the valid norms and directives.

On request, CE Certificates of Conformity for our products are available.

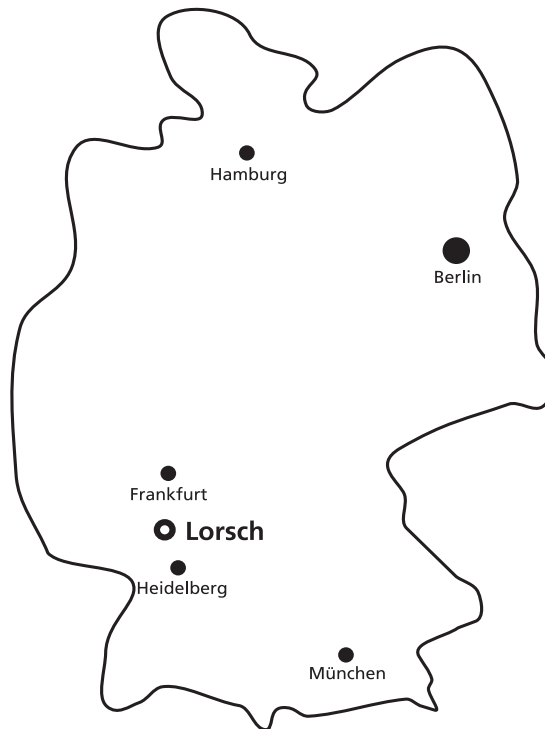

HORST GmbH

Bitzenheimer Weg 10
64653 Lorsch
Germany

P.O. Box 1247
64648 Lorsch
Germany

Phone +49 (0) 6251 9626 0
Fax +49 (0) 6251 9626 96

E-Mail info@horst.de
Internet www.horst.de





HORST GmbH

Bitzenheimer Weg 34
64653 Lorsch

Germany

Phone +49 (0) 6251 9626 0

Fax +49 (0) 6251 9626 96

info@horst.de

www.horst.de

Catalog No. 15